

A Problem-Solving Approach for the Improvement of Management Systems

著者	Kimata Noboru, Lamas O., Luis F.
journal or publication title	金沢大学工学部紀要 = Memoirs of the Faculty of Technology Kanazawa University
volume	16
number	1
page range	1-15
year	1983-03-30
URL	http://hdl.handle.net/2297/25242

A Problem-Solving Approach for the Improvement of Management Systems

Noboru KIMATA^{*} and Luis F. LAMAS O.^{**}

Abstract

Ideas or attempts at solving the managerial problem must be evaluated in a practical, implementation-oriented way. In this paper we propose a systematic problem-solving approach, supported by several techniques, demonstrate its potential for systematizing ideas or attempts, and give a perspective to them.

A distinctive feature of this approach is that the ideas generated at the problem-solving process are fed back into the problem-recognition process, and are thereby modified and strengthened. This feedback, modification and strengthening is done using a comprehensive structural model supplied by the computer-aided Visual Interactive Structural Modelling System (VISMS)

In this paper, the idea of introducing Q. C. circles into Western companies is discussed in detail, using the structural model developed by VISMS. We also criticize the element-oriented approach to this problem as an obstacle to success, and propose certain system-oriented modification to the idea.

1. Introduction

Many Western business organizations today appear to have reached a point of stagnation or crisis, simultaneous with a noticeable decline in the effectiveness of traditional business methods. Among the problems that are widespread, we can mention the declines in productivity, in profits and market share, in the quality of products, and in labor-management relations.

With respect to this situation, we find that several attempts are being made by business to overcome these problems ; however, these are still being made from a limited perspective, and it is generally acknowledged that better and more practical ideas are needed. At the same time, scholars, and even some executives, are paying more attention to the actual circumstances of the current crisis, agreeing to a certain extent that the basic problem is managerial.

We agree with this judgment ; for example, we believe that the decline in productivity cannot be solved only from the technological, or only from the labor, point of view, because then we would not have an integrated description of the problem, its elements and interrelations, and we would fall into the common mistake of solving it only partially and for the moment. Regarding this point, Professor Deming, the quality-control expert, says: "Eighty-five percent of the

^{*} Dept. of Engineering Sciences.

^{**} Dept. of Electorical Engineering (Graduate Student)

problem of low productivity in American business is a management problem....”¹¹

Consequently, we see the necessity for a broader and more pragmatic perspective, one that enables us to find and treat the problem at its roots, and from a wholistic point of view.

The foregoing conclusion led us to focus on the research currently being done on this problem. Among the solutions proposed, the one that attracted our attention was the possibility of introducing Japanese-style management, which is currently one of the most effective and successful, into Western organizations.

In analyzing the current material available on this subject, we found that these works tend toward three different conclusions. The first group concludes that it is unfeasible, in fact, impossible, to introduce Japanese-style management because of the different culture upon which Japanese practices are based. Here we found a primary recognition of the problem and of the possibility of integrating some characteristics of this particular management style into the Western system. However, this recognition is followed by an almost immediate judgment of rejection, and there is no further development of the potential this possibility may have. The option of introducing lifetime employment would be a typical case. The second group remains in a neutral position, seeing the necessity for new ideas, but also seeing a need for more and better strategies for their implementation. In these works, there is not only the initial recognition, but also a conception of the possibility of putting these ideas into effect. However, this group remains at a point where there is still a necessity for further research. We can mention here William Ouchi's Theory Z¹³ and, on a lesser scale, The Art of Japanese Management by Pascale and Athos,¹⁴ works in which new insights are presented, but without a pragmatic and definite plan to follow. The last group examines the implementation of certain characteristics of Japanese-style management in different situations. Within this group three categories may be clearly defined. The first one concerns the programs that failed, mostly because of direct, unmodified implementation and the lack of a correct understanding of, and involvement in, the problem itself. Some of these cases involve the introduction of Q. C. circles into certain American companies.¹⁰ The second category concerns certain organizations that are in the actual process of implementation, or that have done this recently, and where it is still too early to tell whether the effort will become a success or a failure. We can mention, as an example, the recent U. S. Export Trading Company Act.¹⁸ Finally, there are the cases in which some characteristics have been implemented successfully--although these are only isolated instances. Motorola and Warwick Electronics are two examples: These companies were taken over and successfully reformed by Matsushita and Sanyo, respectively.¹⁷

An analysis of the literature has thus led us to conclude that the need exists for further and more concrete research, for the purpose of developing additional, and modifying current, ideas and attempts. This will permit us to obtain appropriate directions for future research, and will lead to better, more numerous, and more practical results. Before we can know the suitable direction for further research, however, we first need a methodology that can systematize the various ideas and place them in a perspective.

In this paper, therefore, we propose a systematic problem-solving approach, supported by various techniques; we demonstrate its potential for systematizing ideas; and we indicate future

directions for research. Among its other assets is the fact that this approach enables us to :

- (a) understand the comprehensive structure--consisting of the interrelations among all the relevant elements in the environment--in which the proposed idea or attempt is imbedded ;
- (b) identify at what stage these ideas are located on the way to implementation ; and
- (c) permit both managers and workers to participate in the problem-solving process, since it is also essential, for the implementation of any idea, to involve the human factor in the process.

With reference to the techniques that support this model, we want to mention the VISMS (Visual Interactive Structural Modelling System) of one of the authors,⁷ which is based on the ISM (Interpretive Structural Modelling) of J. N. Warfield²⁰ ; the DO-IT CATALYSIS of Robert Olson,¹² which deals with the art of creative thinking ; and the SYNECTICS of J. J. Gordon and George Prince,¹⁵ which also involves creative behavior. In the second section of this paper, we will describe the model and its supporting techniques in more detail.

The third section consists of the application of this methodology to a variety of problems, for the purpose of demonstrating its usefulness. Here we will present a general description of specific cases in which we have applied our approach ; for example, concerning the problems that arise when introducing Q. C. circles into Western companies. The examples presented will be described in much greater detail in the companion papers now under preparation.

Finally, in the last section we will summarize the conclusions that we have reached while trying to apply our process to these problems and possible directions for further research.

2. Methodology of Our Approach

2. 1 Systematic Problem-Solving Process Model

As we have seen before, the existing problem is managerial, which implies that it is very comprehensive and very practical. In other words, ideas or attempts at solving this problem must be evaluated in an implementation-oriented way. It therefore becomes important to develop a methodology of approach which achieves the following goals :

- (a) To reveal the comprehensive structure--consisting of the interrelations among all the relevant elements in the environment--in which the proposed idea or attempt is imbedded.
- (b) To identify at what stage the idea or attempt is located on the way to implementation.
- (c) To permit not only managers but also workers to participate in the problem-solving process.

The systematic problem-solving process model proposed here provides an approach that fulfills these objectives. This model consists of three stages :

- (i) Problem-Recognition Process.
- (ii) Problem-Solving Process.
- (iii) Implementation and Feedback Process.

The basic process of this model is outlined in Figure 1, and the details are shown in Figures 2 and

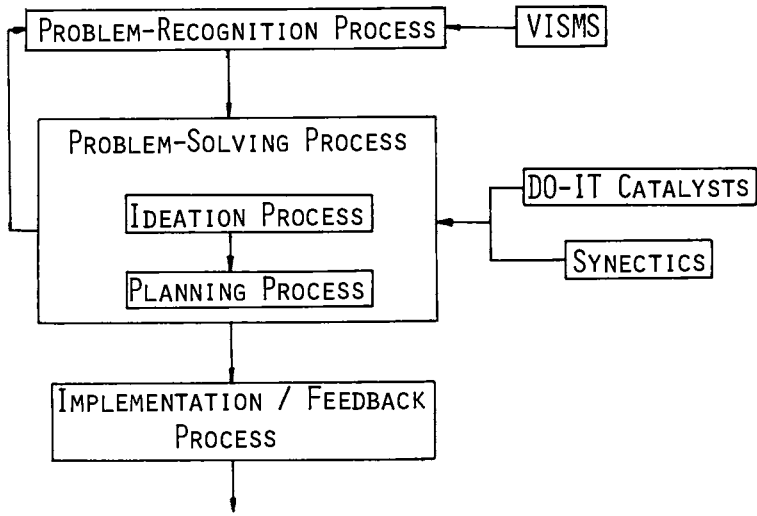

Fig. 1 Basic Process of the Systematic Problem-Solving Process Model

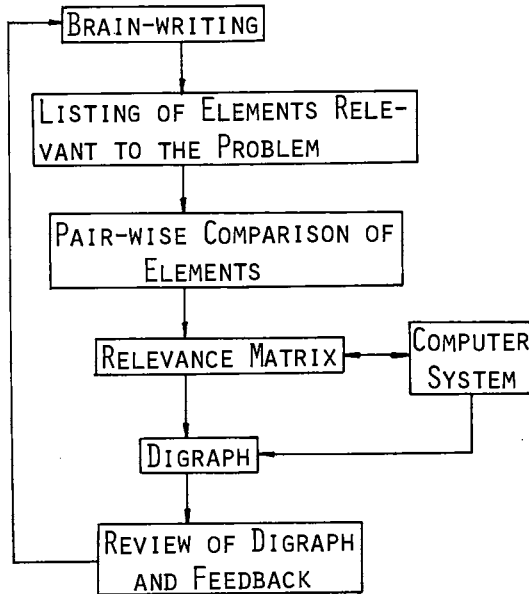

Fig. 2 Basic Steps of the Problem-Recognition Process Supported by VISMS

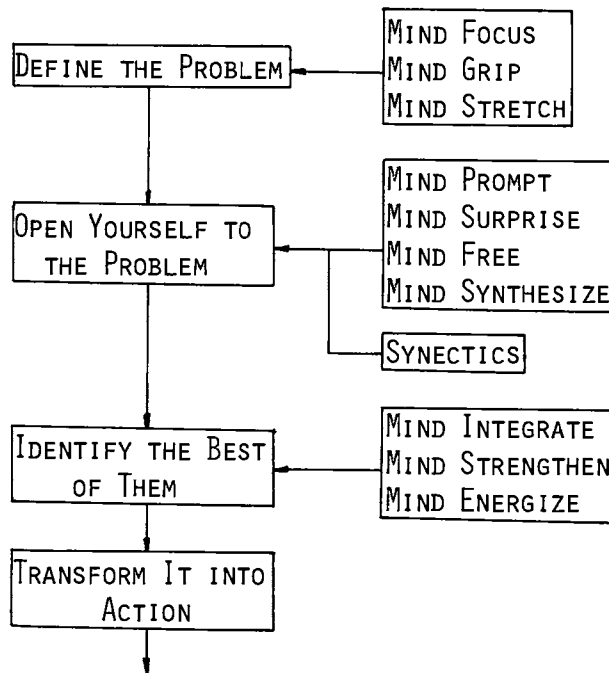

Fig. 3 DO-IT Model of the Problem-Solving Process

3.

Many of the models and approaches currently employed begin with the assumption that the problem is given. Nevertheless, it is true that "in many respects, finding the problem can be much more difficult than the subsequent steps of solution."² The systematic problem-solving process model shown in Figure 1 begins therefore with the problem-recognition process, strengthened by a computer-aided morphological information-processing system developed by one of the authors and named VISMS. A problem or object that is not well-defined can be structuralized through this process, using the relevant elements. The problem-solving process only begins after this first stage has been completed. As we will see later, VISMS is an easy participative system. Each participant can use VISMS to deepen and widen his or her understanding of the problem or object without any great knowledge of computers or mathematics (see (c) above). VISMS can provide a visual digraph (directed graph) of the comprehensive structure of the problem. Participants can exchange their views explicitly through this graph and thus develop further their understanding of the comprehensive structure (see (a) above).

The second stage, the problem-solving process, is divided into several steps. R. W. Olson, for example, divides it into four steps, as shown in Figure 3, and calls it the DO-IT model.¹² The first three steps in this figure correspond to the Ideation Process in Figure 1, but the fourth step corresponds to two processes in our model, Planning and Implementation/Feedback. The steps of the Ideation Process can be supported by the catalysts listed in Figure 3 or by well-known Synectics techniques.¹⁵ An example of the "Mind Focus" catalyst will be shown in the Third

Section, Part 1, of this paper.

As we can see in Figure 1, the idea generated at this Problem-Solving stage is fed back into the Problem-Recognition stage. In this way, by focusing on the idea, we can redevelop and clarify the structural model in which this idea is imbedded. Through this redeveloped model, then, we are able to modify and strengthen any idea.

This systematic process model also enables us to identify the stage at which the idea or attempt is located on the way to implementation ; that is, each can be classified into one of the following stages : Problem Recognition, Ideation, Planning, or Implementation/Feedback (see (b) above).

2. 2 Visual Interactive Structural Modelling System (VISMS)--A Supporting System

There is strong evidence that the unconscious mind is a reservoir of information so vast and rich that it challenges the imagination.² But it is also true that confusion and inconsistency are inherent in the unconscious, and it therefore cannot be of use to us until this confusion and inconsistency are eliminated.

VISMS has been developed as a computer-aided supporting system to externalize our recognition and to eliminate the undesirable features of the unconscious mind through the feedback process. The hardware system of VISMS is shown in Figure 4, while the basic steps of its process were already shown in Figure 2. As we can see from this figure, the first steps in the process involve (a) listing all the elements relevant to the problem, and then, (b) through a pair-wise comparison of them, deriving a relevant matrix of their interrelations. We will now outline the operating manual and some performances.

As may be seen in Figure 5, we first need to select a mode, "new data" or "change matrix entries," and input "0" or "1", depending on the selected mode. If we select the "new data" mode

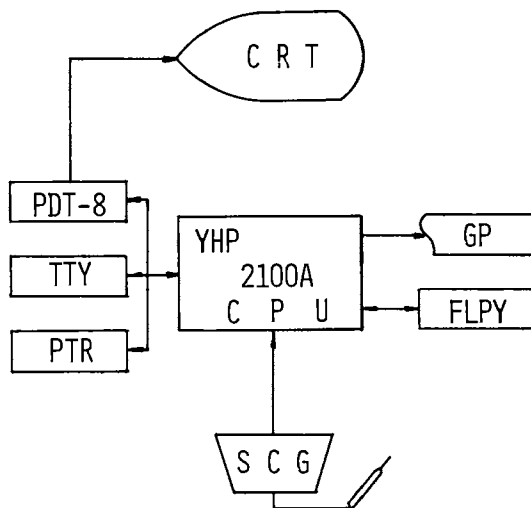

Fig. 4 Hardware System of VISMS

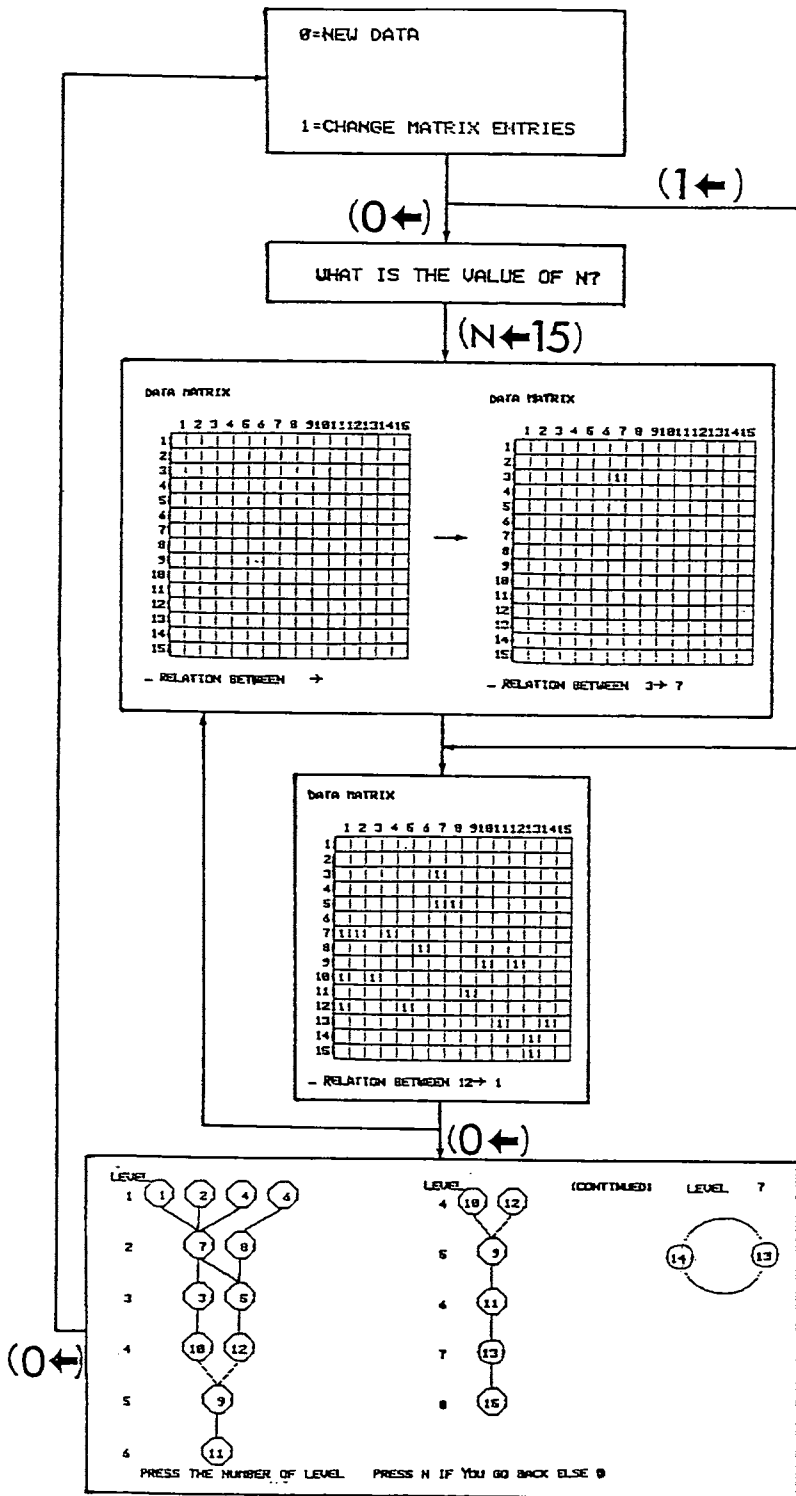

Fig. 5 Operating Manual and Performance of VISMS

and input "0," the message "What is the value of N?" appears on the CRT. "The value of N" means the total number of elements listed during the first step of the VISMS process (Figure 2). After inputting this number from the SCG, a $N \times N$ matrix is automatically drawn on the CRT.

Next, we input the information on the relations between the elements "i" and "j" into the relevant matrix, and a "1" is displayed at the intersection of the i-th row and the j-th column in the matrix on the CRT (see data matrix, Figure 5). Of course, $d_{ij}=1$ is stored. Once all the inputting of these relations is finished, input "0", and a digraph as shown in Figure 5 is drawn on the CRT. Amendment of the relations can be done easily by inputting the numerical values for i and j, after inputting a number greater than N.

One of the most important features of this system is that it can present a digraph in which indirect relationships, such as that between elements "12" and "1" (data matrix, Figure 5), are broken down into a chain of direct ones, such as "12" to "5", "5" to "7", and "7" to "1". This feature helps decrease the confusion and inconsistency existing in the powerful, but not well-structured, unconscious thinking. It also helps decrease the burden on the users because they do not need to pay attention to whether the relation is direct or not. Finally, after reviewing the digraph, inputting "0" permits us to repeat this procedure several times, easily and rapidly, until we achieve a well-structured recognition of our thinking.

3. Problem-solving Approach to The Managerial Problem

3.1 An Overview of the Attempts or Ideas of the "Learn from Japan" Movement

3.1.1. General Overview

"If you are able to state a problem, it can be solved....Careful definition of the problem not only helps to insure that we are solving the right problem, it provides us with an overview of the problem."¹² The Mind Focus catalyst helps us to do this. The mechanism of this catalyst is shown in Figure 6.

From researchers' works, newspaper articles, etc., we can detect an increasing interest in

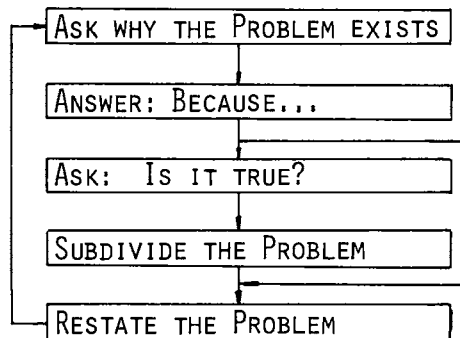

Fig. 6 Procedure of the Mind Focus Catalyst

learning from Japan, not only in the neighboring Asian countries, but also in the U. S. and Europe. In order to obtain an overview of the problem concerning the “learn from Japan” movement, we adopted the procedure outlined in Figure 6. The typical flow of discussion along this line is as follows :

1st Phase : Why do they try to learn from Japan?

Answer : Because the Japanese economy is very successful.

Is this true?

Answer : Yes. Big surplus, big market share, low unemployment rate, etc., show this.⁴

2nd Phase : What is the reason that the Japanese economy is successful?

Answer : The main reason is that Japanese companies are strongly competitive.

Is this true?

Answer : Yes. Japan enjoys a clear lead in industrial competitiveness over other developed countries.¹⁶

3rd Phase : Why are the Japanese companies so competitive?

Answer : Because they have achieved high productivity, high quality of products, and an excellent understanding of the dynamics of the marketplace.

Is this true?

Answer : Yes. Available data demonstrate these features.¹⁶

4th Phase : Why have they achieved such features?

Answer : Because they have established excellent management systems.

Is this true?

Answer 1 : Yes. Japanese know how to manage better than we do.¹³

Yes. There is no question about it. About 3/4 of Japanese firms are well run, while only 1/4 of American companies are well managed.²²

Answer 2 : I think so, but I don't know Japanese management systems very well. It is important to study them more deeply.

From this discussion, we found that the intent is to learn some excellent parts of the Japanese management system (WHAT) in order to obtain high productivity, high quality of products, and a better understanding of the dynamics of the marketplace, thereby achieving stronger competitiveness (WHY). Also, while explaining this “what and why,” we encountered certain restraints, mostly due to the fact that the data on which our reasoning is based is of course historical, and thus does not allow us to know whether or not the current situation will continue in the future.

In general, then, the application of this procedure permits us to simplify the problem after each restatement, to explain the “what and why,” and to recognize the limitations of our thinking. These results act as feedback for the purpose of deepening the analysis and indicating further directions.

3.1.2. Overview of Specific Attempts or Ideas

In this part we focus on some concrete examples of WHAT different groups are now trying to introduce into their own management systems. These examples are listed in Table 1. In this

table we want to point out that the first two examples are element-oriented attempts, while the last two are total-system-oriented attempts.

Researchers in creative thinking have demonstrated that it is very important to delay judgment while trying to generate new ideas or fresh insights.² It is thus necessary for us to ask here: "Are these attempts or ideas consistent with their revealed objectives?" and "Are they being considered thoroughly?"

We can briefly summarize the present status of each of the above attempts as follows:

- (i) Lifetime-employment system.⁹ Even though it is still generally said that this is difficult to introduce because of cultural differences, a modified version of this system can be found in some Western companies. The recent introduction of lifetime employment by Ford Motor Company at one of its plants is, however, a special case.
- (ii) Quality control circles.⁵ Many companies are trying this idea in different countries. Some of them have had a certain degree of success, while others have met with failure.¹⁷
- (iii) Export trading company system.¹⁸ This is a particular case, the idea already having been converted into a law in the U. S. According to Keach and Sampson,⁶ through this act the U. S. administration is attempting to implement trade policies that will reverse the trend toward protectionism and result in an easing of export barriers and in more competitive U. S. exports. It only remains to be seen what attitude business will take once actual implementation begins.
- (iv) Z-type management system. Such a system can be observed in some Western companies, but evolved on its own and was not planned. (A plan to follow is proposed by Ouchi in his book Theory Z.)¹³

Based on the above summary, we present in Table 2 an overview of these four attempts from the systematic problem-solving process point of view. By using this overview, together with the

TABLE 1

(i) Lifetime-Employment System
(ii) Quality Control Circles
(iii) Export Trading Company System
(iv) Z-type Management System

TABLE 2

ATTEMPTS PROCESS	Lifetime Employment (i)	Q.C. Circles (ii)	Trading Companies (iii)	Z-type Companies (iv)
I Problem Recognition	●	○	○	●
II Problem-Solving 1) Ideation 2) Planning			●	○
III Implementation	○	●	●	●

NOTES: ● = Majority of Cases. ○ = Few Cases.

available material, we can now indicate directions for further endeavor in each case, as follows :

- (i) Lifetime employment. Because this system is said to be difficult to introduce, most cases are still at the recognition stage (Process I, Table 2) and have not progressed beyond that. However, there are cases of a modified system existing in some Western companies (Process III). We therefore propose to reconsider these attempts, feeding back the results found at Process III into Process I, and integrating them with the results already there, for the purpose of obtaining a better definition of the problem.
- (ii) Q. C. circles. The majority of these cases, as mentioned before, are in the implementation stage (Process III), with some successful and others not. The unsuccessful attempts failed largely because they were element-oriented, ignoring the supporting systems. It is thus necessary to trace the progression of all these cases from Process I through Process III, so that we may obtain a comprehensive understanding of the attempts made so far. The introduction of Q. C. circles is treated more extensively in the second part of this section.
- (iii) Export trading companies. As explained before, this idea is now embodied in a law in the U. S. Our objective here is not to discuss whether or not this law can succeed as it is, but to analyze, using our process model, how it was constructed and to see if a systems treatment exists or not. To do this, it is necessary to trace the process between the problem-recognition stage and the implementation stage.
- (iv) Z-type companies. Here we need to go deeply into each of the current attempts at each individual company, and then proceed through the various stage(s), in order to obtain a more systematic and pragmatic evaluation of the process.

In conclusion, a correct use of this systematic problem-solving process model not only enables us to obtain an overall and more precise view of the current situation, but it also reveals what is still needed and how we can further develop these attempts or ideas in a suitable and pragmatic direction.

3. 2 Structuralization of the Introduction of Q. C. Circles

As we saw in Table 2, the majority of these cases are in the implementation stage (Process III), with some of them successful and others not. Also, as we suggested, it is important to trace the process from the problem-recognition stage through the implementation stage. The various studies on Japanese management systems can help us to do this. The general problem-recognition structure of these studies is shown in Figure 7. By using it, we will be able to

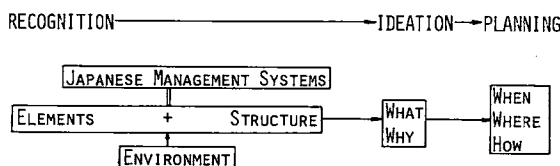

Fig. 7 General Structure of Studies on Japanese Management Systems

generate ideas as "what" and clarify the reasoning of "why."

For our example, we are selecting the introduction of Q. C. circles as the "what," in order to obtain high productivity, high quality of products, a better understanding of the dynamics of the marketplace, and achieve strong competitiveness ("why").

In our model, the idea, generated at Process II, is fed back to Process I and a more comprehensive structural model, focused on the idea, is redeveloped using VISMS, the basic steps of which were shown in Figures 2, 4, and 5. In following this process, we first try to gather elements relevant to the attempt from the references listed at the end of this paper. In Table 3 we present a list of these elements.

TABLE 3

No.	Element
1	Competitiveness
2	High Productivity
3	High Quality of Products
4	Excellent Understanding of the Dynamics of the Marketplace
5	Loyalty
6	Company-Wide Q.C. Circles
7	Lifetime-Employment System
8	Promotion by Seniority
9	Lifelong Job-Rotation System
10	Collective Value Orientation
11	Ability and Incentive of Individuals
12	Education Systems
13	Bonus Payments
14	Temporary Employment
15	Satellite Firms
16	Social Tradition
17	Company Trade Union
18	Trust
19	Subtlety
20	Intimacy
21	Workers' Morale
22	.
23	.
24	.

	1	2	3	4	5	6	7	8	9	10	11	12	13	14	15	16	17	18	19	20	21	22	23	24
1																								
2	1																							
3	1																							
4	1																							
5	1																							
6	1	1	1	1	1																			
7																								
8																								
9																								
10																								
11	1	1	1	1	1	1	1	1	1	1	1	1	1	1	1	1	1	1	1	1	1	1	1	1
12	1	1	1	1	1	1	1	1	1	1	1	1	1	1	1	1	1	1	1	1	1	1	1	1
13	1	1	1	1	1	1	1	1	1	1	1	1	1	1	1	1	1	1	1	1	1	1	1	1
14	1	1	1	1	1	1	1	1	1	1	1	1	1	1	1	1	1	1	1	1	1	1	1	1
15	1	1	1	1	1	1	1	1	1	1	1	1	1	1	1	1	1	1	1	1	1	1	1	1
16	1	1	1	1	1	1	1	1	1	1	1	1	1	1	1	1	1	1	1	1	1	1	1	1
17	1	1	1	1	1	1	1	1	1	1	1	1	1	1	1	1	1	1	1	1	1	1	1	1
18	1	1	1	1	1	1	1	1	1	1	1	1	1	1	1	1	1	1	1	1	1	1	1	1
19	1	1	1	1	1	1	1	1	1	1	1	1	1	1	1	1	1	1	1	1	1	1	1	1
20	1	1	1	1	1	1	1	1	1	1	1	1	1	1	1	1	1	1	1	1	1	1	1	1
21	1	1	1	1	1	1	1	1	1	1	1	1	1	1	1	1	1	1	1	1	1	1	1	1

Fig. 8 Data Matrix of Attempt to introduce Q. C. circles

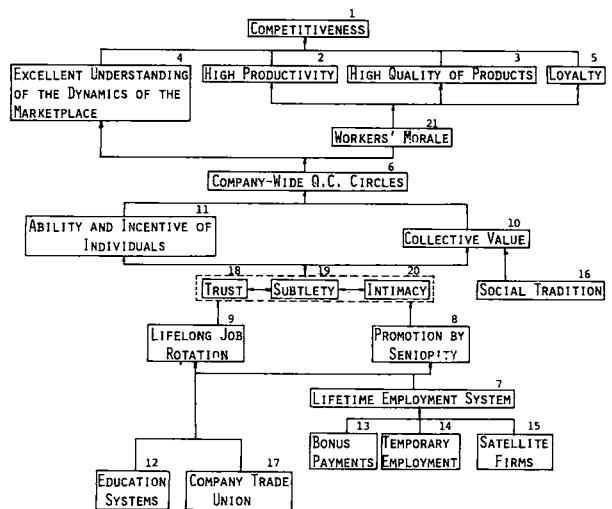

Fig. 9 Structuralization of Introduction of Q. C. circles

The next step is the pair-wise comparison between them. Through doing this, we try to identify the relationship between the elements by using a question such as : "Does the element *i* contribute to the increase of element *j* ?" Figure 8 is one result of such a process. In this figure, a "1" indicates a relationship between the two elements.

After completing this comparison, with the help of VISMS we are able to draw a digraph of the structure of this attempt. Figure 9 is the result obtained. Of course, this digraph is not the final one. If we cannot interpret it well, or if we do not obtain enough from it, we can change the data matrix (Figure 8) or add some elements (Table 3) and try to get a new digraph, repeating the procedure.

Discussion

From the digraph shown in Figure 9, we are now able to discuss some problems relevant to the introduction of Q. C. circles.

First, elements 1, 2, 3, and 4 are the objectives revealed as the WHY in the earlier part of this section. The digraph shows that there exists a hierarchical relationship among them. The final goal is to achieve competitiveness (1), and increases in productivity (2), in the quality of products (3), or in understanding the dynamics of the marketplace (4) are all means to achieve this goal. At the same level as elements 2, 3, and 4, we found that the increase in loyalty (5) is also a mean to this end.

Moving to the next level, we see that company-wide Q. C. circles (6) can contribute indirectly to objectives 2, 3, and 5, through the increase in workers' morale (21), and we found that can also contribute directly to the increase of objective 4.

In turn, we observe that the ability and incentive of individuals (11) and the collective value (10) play a key role in Q. C. circles.

Through job rotation (9) and promotion by seniority (8), we see that a certain level of trust, subtlety, and intimacy (18, 19, 20) is developed, which in turn contributes to the achievement of elements 10 and 11.

Social tradition (16) is at the same level as elements 18, 19, and 20, since it is intrinsic to the development of collective value (10).

The lifetime employment system (7), which is also an attempt at the same level with Q. C. circles (Table 1), act in this case as a supporting system of this attempt. This same reasoning can be applied to elements 8 and 9. The lifetime employment contributes to the achievement of elements 8 and 9, while bonus payments (13), temporary employment (14), and the satellite firms (15) form the basis for the achievement of lifetime employment. At the same time, the education systems (12) and the company trade union (17) are important to achieve element 9, and also play some role in achieving element 8.

We should also mention here that we have found that is necessary to break down certain elements (e. g., 11, 12, and 16) a little further, in order to get a more detailed and comprehensive picture of the overall situation.

Finally, from this discussion we can obtain the next conclusions : (i) This digraph shows that it is crucially important to see any idea or attempt from a comprehensive way, and, (ii) This type of representation can permit workers' participation, because of easy going form. They can

contribute to this procedure in many ways, e. g. proposing some elements that managers forget.

4. Conclusion

We can summarize our findings as follows :

- (1) Through the application of this problem-solving approach, we can obtain a proper restatement of the problem that gives us a broader view of it.
- (2) We can also identify at what stages various ideas or attempts are located along the process from recognition to implementation. This, in turn, enables us to use the available cognitive material in a functional way and to find directions for further efforts.
- (3) By feeding the idea generated at the problem-solving stage back into the problem-recognition stage, we are able to redevelop and clarify the structural model in which the idea is imbedded. This not only gives more depth to the idea itself, but also enables both managers and workers to come to a fuller understanding of it.
- (4) Lastly, all the findings obtained through the use of this approach reveal that, in order to increase the feasibility of any idea or attempt, it is crucial that it be viewed and treated in a comprehensive, systematic way. We thus reject the element-oriented approach as an obstacle to successful implementation.

At this point, we would just like to mention that, in the course of our research, we found that certain problems also exist in the Japanese management system. Concerning lifetime employment, for example, companies are having problems as the population ages and the number of new employees declines. For the same reason, the seniority system is threatened by the fact that there are fewer managerial positions for newcomers. Another problem lies in the changing attitudes of the younger generation. Still, another, on the technological side, is the increasing need for greater research and development. These problems, too can be pragmatically analyzed by means of our approach, and will be considered later in a corollary to this paper.

In conclusion, we sincerely hope that the presentation of this new problem-solving approach will encourage others to continue studying and perfecting this idea. We also wish to point out that, due to the lack of materials on this specific topic, this paper undoubtedly contains certain errors and limitations. Nevertheless, we hope that this effort of ours will not only provoke criticism, but will also spur others into viewing the management problem from a new perspective.

References

- 1) European Economy : Annual Economic Report 1981-1982. Commission of the European Community. Bruxelles, No. 10 (November 1981) and No. 11 (March 1982).
- 2) Gregory, S. A. Creativity and Innovation in Engineering. London Butterworths, 1972.
- 3) Intereconomics, July/August 1982.
- 4) International Financial Statistics. IMF, Vol. XXXV, No. 9, September 1982.
- 5) Ishikawa, Kaoru. Quality Control in Japan : Company-Wide Quality Control (CWQC). Dentsu Japanese Marketing Advertising, No. 20 (Spring-Summer 1982), p.p. 4-18.
- 6) Keach, Kenneth and Margaret Sampson. The American Export Trading Company : New Ally or Formidable

Competitor? The Journal of the ACCJ (March 1982), p.p. 69-70.

- 7) Kimata, Noboru. On development of a computer-aided Visual Interactive Structural Modelling System. Memoirs of the Faculty of Technology, Kanazawa University, Vol. 13, No. 1, 1980, p.p. 9-18. (In Japanese)
- 8) —. Study on a Visual Interactive Structural Modelling System for Social Planning System. Transactions of JSCE, Vol. 12, 1980, p.p. 217-218.
- 9) Kubota, Akira. Japanese Employment System and Japanese Social Structure. Asian Pacific Community, No. 15 (Winter 1982), p.p. 96-120.
- 10) —. "America Inc., not so simple to create", The Japan Times, August 1, 1982, p. 14.
- 11) NBC Report. "If Japan can, Why can't we?" Interview with Professor Deming. June 24, 1980.
- 12) Olson, Robert. The Art of Creative Thinking. Barnes and Noble Books, 1978.
- 13) Ouchi, William. Theory Z : How Americans can meet the Japanese challenge. Avon Books, 1982.
- 14) Pascale, Richard and Anthony Athos. The Art of Japanese Management. Penguin Books, 1982.
- 15) Prince, George. The Operational Mechanisms of Synectics. The Journal of Creative Behavior, Vol. 2, No. 1 (Winter 1967), p.p. 1-13.
- 16) Report on Industrial Competitiveness 1981. European Management Form.
- 17) Schroeder, Roger. Operations Management. Mc Graw-Hill, 1982, p.p. 532-538.
- 18) The Export Trading Company Act of 1981. U. S. 97th Congress, 2^d Session, H. R. 1799. February 2, 1982.
- 19) The Export Trading Company Act of 1982, Bank Export Services. U. S. 97th Congress, 2^d Session, Bill 00734. Introduced on March 18, 1981, and signed by President on October 8, 1982.
- 20) Warfield, John. On Arranging Elements on Hierarchy in Graphic Form. IEEE, Transactions on Systems, Man and Cybernetics, Vol. SMC-3 (March 1973), p.p. 121-132.
- 21) —. Extending Interpretive Structural Modelling. Proceeding of 7th Annual Pittsburgh Conference on Modelling and Simulation (April 1976), p.p. 1163-1167.
- 22) "What Americans Business can learn from Japan." Interview with Richard Pascale and Akio Morita. U. S. News and World Report, 1982.