

Measurement of solubilities for rhodium complexes and phosphine ligands in supercritical carbon dioxide

著者	Shimoyama Yusuke, Sonoda Masanori, Miyazaki Kaoru, Higashi Hidenori, Iwai Yoshio, Arai Yasuhiko
journal or publication title	Journal of Supercritical Fluids
volume	44
number	3
page range	266-272
year	2008-04-01
URL	http://hdl.handle.net/2297/9658

doi: 10.1016/j.supflu.2007.09.028

**Revised manuscript submitted to The Journal of Supercritical Fluids
(SUPFLU-D-07-00060)**

Measurement of solubilities for rhodium complexes and phosphine ligands in supercritical carbon dioxide

Yusuke Shimoyama^{a,*}, Masanori Sonoda^a, Kaoru Miyazaki^a, Hidenori Higashi^b, Yoshio Iwai^a and Yasuhiko Arai^a

^aDepartment of Chemical Engineering, Faculty of Engineering, Kyushu University
744 Motoooka Nishi-ku, Fukuoka 819-0395, JAPAN

^b Division of Material Engineering, Graduate School of Natural Science & Technology,
Kanazawa University, Kakuma-machi Kanazawa-shi, Ishikawa 920-1192, JAPAN

* To whom correspondence should be addressed.

Tel & Fax: +81-92-802-2771, E-mail: yshimo@chem-eng.kyushu-u.ac.jp

Abstract

The solubilities of phosphine ligands and rhodium (Rh) complexes in supercritical carbon dioxide were measured by circulation method with a Fourier Transform Infrared (FT-IR) spectroscopy at 320 and 333 K and several pressures. Triphenylphosphine (TPP) and tris(*p*-trifluoromethylphenyl)phosphine (TTFMPP) were selected as ligands which compose the Rh complex. The solubilities of the fluorinated ligands and complexes were compared with those of the non-fluorinated compounds. It was found that the solubilities of Rh complexes are enhanced by introducing trifluoromethyl group to the ligand. The experimental data was correlated by Chrastil equation. The correlated results are in good agreement with the experimental data. Furthermore, the solvation numbers of carbon dioxide around the ligands and Rh complexes were obtained from the slope of Chrastil equation. The solvation number for the fluorinated compounds are larger than those for the non-fluorinated compounds.

Keywords : solubility; supercritical carbon dioxide; phosphine ligand; Rh complex; fluorination

1. Introduction

Supercritical fluid technologies have been actively applied and used commercially for extraction, fractionation, and purification in chemical, food and pharmaceutical industries. In particular, supercritical carbon dioxide (SCCO₂) whose critical temperature and pressure are 304.2 K and 7.3 MPa has been frequently used because it can reach the supercritical state under relatively mild conditions. Also carbon dioxide is cheap, stable and inflammable.

SCCO₂ has also received much attention as a reaction medium. A large number of studies concerning the organic syntheses in SCCO₂ have been reported [1-3]. In these SCCO₂ processes, there has been a problem that the catalysts generally used in organic syntheses are hardly dissolved in SCCO₂. The enhancements of catalyst solubilities in SCCO₂ are needed for the increase of the reaction rates. Some studies have reported that the solubilities in SCCO₂ are enhanced by the fluorinations of the solutes for the metal complexes [4-6], ligands [7], polymers [8], pharmaceuticals [9] and surfactants [10]. Tsukahara et al. [6] have reported the solubilities of uranyl β -diketonato complexes in SCCO₂ at 40 °C and 10.0 – 25.0 MPa. Acetylacetonate, trifluoroacetylacetonate and hexafluoroacetylacetonate were selected as the ligands. It has been reported that the solubilities of the fluorinated complexes in which the ligands were trifluoroacetylacetonate and hexafluoroacetylacetonate were larger than those of the complex with acetylacetonate. The solubilities of the fluorinated phosphates in SCCO₂ at 300.0 – 330.0 K have been also reported by Wagner et al [7].

Fujita et al. [11,12] have reported that the Rh complexes with the fluorinated phosphate ligand was more effective in the hydroformylation of the dienes to dialdehydes in SCCO₂ than those with non-fluorinated ligands. Ru complexes with the

fluorinated phosphine have been adopted to the hydrogenation of the unsaturated aldehyde by Zhao et al. [13] It is very important and useful for these reaction design to understand the relationships between the solubility increase of these catalyst by the phosphate ligand fluorination and the reaction promotion. Unfortunately, no experimental data of the solubilities for these catalysts in supercritical carbon dioxide is available.

In this work, the solubility data of the phosphine ligands and Rh complexes in SCCO₂ are reported. The measurements of the solubilities were performed by circulation method with a Fourier Transform Infrared (FT-IR) spectroscopy at 320 and 333 K and 8.96 – 15.94 MPa. Triphenylphosphine (TPP) and tris(*p*-trifluoromethylphenyl)-phosphine (TTFMPP) were selected as the phosphine ligands which compose Rh complexes. The solubilities of the fluorinated ligands and Rh complexes were compared with those of the non-fluorinated compounds. Moreover, the experimental data was correlated by the Chrastil equation [14]. The solvation numbers of carbon dioxide around the solutes were obtained from the slope of Chrastil equation.

2. Experiment

2.1 Materials

TPP was supplied by Aldrich Co. with a purity higher than 99%. TTFMPP was supplied by Azmax Co. with a purity higher than 97% by a gas chromatograph analysis. Carbonylhydridtris(triphenylphosphine)rhodium (Rh-TPP) was supplied by Wako Co. Carbon dioxide was supplied by Sumitomo Seika Co. with a purity higher than 99.9%. The substances were used without further purification. Structural formulas of phosphine ligands and Rh complex are shown in Figures 1 and 2, respectively. As Rh complex

composed of TTFMPP (Rh-TTFMPP) is not commercially available, Rh-TTFMPP was synthesized in this work. (Acetylacetonato)-dicarbonylrhodium(I) purchased from Wako Co. was used for the synthesis of Rh-TTFMPP. The synthesis procedures of Rh-TTFMPP are described in the subsequent section.

2.2 Apparatus and procedure

A circulation-type apparatus combined with on-line FT-IR spectroscope is shown in Figure 3. The apparatus in this work was similar to that in the previous work [15-17] and the detail descriptions of the apparatus have been given there. The circulation part of the apparatus equipped the circulation pump(9), FT-IR spectroscope(10) and equilibrium cell(11) with sapphire windows. The circulation part was immersed in a water bath(14) and controlled in the focused temperature within ± 0.1 K. The pressures in the system were maintained within ± 0.25 MPa during the measurements. The FT-IR spectroscope(10) was adopted to measure the compositions of the solute in supercritical fluid phase.

The relationships between the molarities of the solute and the absorbance of the specific peak were calibrated with Lambert – Beer law by the following procedure before the solubility measurements. The known amounts of the ligand or complex were dissolved in supercritical carbon dioxide. It was confirmed the formation of the homogenous phase with the windows of the cell. Then the absorbances of the specific peak were measured with FT-IR spectroscope and the calibration curves were formed. In the measurements of solubilities, at first, the solute was set into the equilibrium cell(11). After sealing the cell, carbon dioxide was supplied from a cylinder(1) and

liquefied through a cooling unit(4). The liquefied carbon dioxide was provided to the system by a feed pump(5). The carbon dioxide achieved to the supercritical state through the preheating coil(7) and entered into the equilibrium cell(11). After the pressure was reached to the desired condition, the fluid in the system was circulated. The compositions of the solute in SCCO₂ were analyzed with the FT-IR spectroscope(10). For Rh-TTFMPP, the synthesis of this complex was carried out before the solubility measurements. (Acetylacetonato)-dicarbonylrhodium(I) and TTFMPP in mole ratio 1 : 4 were located in the equilibrium cell. Then, the system was reached to the desired conditions by the operations described above. The synthesis was performed at 333 K and 4.0 MPa for 4 – 14 hs.

In the IR analyses, FT-IR spectroscope was purged with dry N₂. The IR spectra were measured at 4 cm⁻¹ wavenumber resolution to obtain the desired signal-to-noise ratio. The optical cell was made from SUS316 and the optical path length was 5.0 mm. The windows of the optical cell were made of ZnSe and the thickness was 8.0 mm. The optical cell was maintained to the desired temperatures with water pumped from a water bath(14). The absorption spectra of pure carbon dioxide at each temperatures was utilized as the reference spectra. The IR spectra of the solutes were determined by subtracting those of pure carbon dioxide from those of the mixture of solute and carbon dioxide. The specific peaks of the solutes (Rh-TPP: around 3064 cm⁻¹, Rh-TTFMPP: around 1990 cm⁻¹, TPP: around 3064 cm⁻¹, TTFMPP: around 960 cm⁻¹) were adopted to determine the compositions of the solutes in SCCO₂. Figure 4 shows the IR spectra for TTFMPP and Rh-TTFMPP at 320 K and several pressures. The saturated state was confirmed by the absorbance variation as time. As an example, the absorbance variations in 3064 cm⁻¹ as time for TPP at 320 K and 15.91 MPa are shown in Figure 5.

The saturated solubilities were determined from the constant absorbance as shown by solid line in Figure 5. The molarities in mol L⁻¹ of the solute in supercritical carbon dioxide were determined using the absorbance from the calibration curves. Then, the obtained solubilities were converted to a mole fraction basis using the densities of pure carbon dioxide calculated with the equation of state [18]. The accuracies of the solubility data were within 5 % for the ligands and 10 % for the Rh complexes.

The measured conditions were at 320 and 333 K and 8.96 – 15.94 MPa. From the phase behavior with the view cell, the vapor-liquid equilibria were observed for TPP at 333 K below 10.5 MPa and TTFMPP at all temperatures and pressures. For TPP at the other conditions, the phase states were the solid-vapor equilibria. The phase behavior for Rh-TPP and Rh-TTFMPP was also the solid-vapor equilibria at the temperatures and pressure focused in this work.

3. Correlation

The experimental solubility data of the solutes in SCCO₂ was correlated with Chrastil equation [14]. This equation given by the following can explain simply the relation between the solubilities of solutes in SCCO₂ and the densities of carbon dioxide.

$$\ln S_2 = k \ln \rho_1 + C \quad (1)$$

where S_2 is the solubility of the solute in SCCO₂ in g L⁻¹, ρ_1 is the density of carbon dioxide in g L⁻¹. k corresponds to the number of carbon dioxide molecules associated with the solute. C is the temperature dependent constant related to the enthalpies of vaporization and solvation. The densities of carbon dioxide were calculated by the equation of state proposed by Huang et al. [18]. The parameters k and C were determined from the solubility data obtained in this work.

4. Results and discussion

The experimental results for solubilities of ligands TPP and TTFMPP at 320 and 333 K are shown in Table 1 and Figure 6. Wagner et al. [7] have also reported the solubility data of TPP and TTFMPP in SCCO₂ at 320 K. The comparisons of the solubility data between this work and the literature can be explained from Figure 6. The solubility data for TPP at 320 K in this work are higher than those in the literature. For TTFMPP at 320 K, the data in this work are in good agreement with the literature data in the range of 10.5 – 11.0 MPa. As shown in Figure 6, the solubilities of fluorinated TTFMPP are 2.0 – 9.8 times at 320 K and 2.4 – 7.6 times at 333 K higher than those of non-fluorinated TPP.

For Rh-TPP and Rh-TTFMPP, the solubility data obtained in this work are shown in Table 2 and Figure 7. It is found that the solubilities of Rh complex are much lower than those of their ligands by $10^{-3} - 10^{-1}$. At 333 K, the solubilities of Rh-TTFMPP with fluorinated ligands are about 3 – 30 times higher than those of Rh-TPP with non-fluorinated ligands. These tendencies are the same as in the case of the phosphine ligands. The solubility enhancements for Rh-complexes by the fluorination of the ligands are larger than those of the ligands. The increase ratios of Rh complex solubilities by the fluorination were compared with those of other metal complexes as shown in Table 3. For Rh complexes in this work, the ratio is higher than those of the sodium and uranyl complexes and lower than those of the copper, nickel and cobalt complexes.

Figures 8 and 9 give the correlated results of the solubilities for the phosphine ligands and Rh complexes in SCCO₂, respectively. Linear relationships between the solubilities and the densities of carbon dioxide were successfully obtained for all solutes at each

temperature. The values of k and C in equation (1) determined in this work are listed in Table 4. The parameter k in Chrastil equation means the solvation number of the solvent molecule around the solute molecule. The knowledge of the solvation is very important to understand the mechanism of the solubility increase by the fluorination. The values of k for the fluorinated ligands at 320 and 333 K and fluorinated complexes at 333 K are 1.7, 1.4 and 5.0 times larger than those for non-fluorinated compounds, respectively. This means that the fluorinated ligand or complex molecule interacts more strongly with carbon dioxide molecule by the fluorinations. It is considered that the increases of k correspond to the tendencies of the solubility increase by the fluorination of the phosphine ligands. These results suggest that the solubilities of phosphine ligands and Rh complexes are dominated by the solvation of carbon dioxide around the solutes.

5. Conclusion

The solubilities of the phosphine ligands and Rh complexes in SCCO₂ were measured by circulation method with a FT-IR spectroscopy at 320 and 333 K. From the experimental data obtained in this work, that is demonstrated that the fluorinations of the phosphine ligands enhance the solubilities of the Rh complexes. The experimental data obtained was correlated with Chrastil equation. The correlated results represent the experimental data with the linear relationships between the solubilities and the densities of carbon dioxide. The solvation numbers of carbon dioxide around the solutes were obtained from the correlations. The solvation numbers for the fluorinated ligands and Rh complexes were larger than those of the non-fluorinated compounds. These results can demonstrate that the increases of the solvation numbers correspond to the solubility enhancements by the fluorination of the ligands.

Acknowledgment

The present study was supported in part by a Grant-in-Aid for Scientific search (B), 17360376, 2004, and Grant-in-Aid for the 21st century center of excellent (COE) program, "Functional Innovation of Molecular Informatics" from the Ministry of Education, Science, Sports and Culture, Japan.

Reference

- [1] R. Liu, F. Zhao, S. Fujita, M. Arai, Selective hydrogenation of citral with transition metal complexes in supercritical carbon dioxide, *Appl. Cataly. A* 316 (2007) 127-133.
- [2] B.M. Bhanage, Y. Ikushima, M. Shirai, M. Arai, Heck reactions in supercritical carbon dioxide using organometallic complex catalysts, *High Pressure Res.* 20 (2001) 131-142.
- [3] B. M. Bhanage, S. Fujita, Y. Ikushima, M. Arai, Synthesis of dimethyl carbonate and glycols from carbon dioxide, epoxides, and methanol using heterogeneous basic metal oxide catalysts with high activity and selectivity, *Appl. Cataly. A* 219 (2001) 259-266.
- [4] K.E. Laintz, C.M. Wai, C.R. Yonker, R.D. Smith, Solubility of fluorinated metal diethyldithiocarbamates in supercritical carbon dioxide, *J. Supercritical Fluids* 4 (1991) 194-198.
- [5] N. Dahmen, P. Griesheimer, P. Makarczyk, S. Pitter, O. Walter, Solubility of trans-Co₂(CO)₆[3,5-bis(CF₃)C₆H₃P(*i*-C₃H₇)₂] in dense carbon dioxide, *J. Org. Chem.* 690 (2005) 1467-1473.
- [6] T. Tsukahara, Y. Kachi, Y. Kayaki, T. Ikariya, Y. Ikeda, Spectrophotometric study

- on solubility of $\text{UO}_2(\beta\text{-diketonato})_2\text{dmsO}$ complexes ($\beta\text{-diketonate}$ = acetylacetonate, trifluoroacetylacetonate, hexafluoroacetylacetonate; dmsO = dimethyl sulfoxide) in supercritical carbon dioxide, *J. Supercritical Fluids* 39 (2006) 6-12.
- [7] K.-D. Wagner, N. Dahmen, E. Dinjus, Solubility of triphenylphosphine, tris(*p*-trifluorophenyl)phosphine, tris(pentafluorophenyl)phosphine, and tris(*p*-trifluoro-methylphenyl)phosphine in liquid and supercritical carbon dioxide, *J. Chem. Eng. Data* 45 (2000) 672-677.
- [8] B. Baradie, M.S. Shoichet, Z Shen, M.A. McHugh, L. Hong, Y. Wang, J.K. Johnson, E.J. Beckman, R.M. Enick, Synthesis and solubility of linear poly(tetrafluoro-ethylene-*co*-vinyl acetate) in dense CO_2 : Experimental and molecular modeling results, *Macromolecules* 37 (2004) 7799-7807.
- [9] A. Laitinen, O. Jauhiainen, O. Aaltonen, Solubility of fluorinated pharmaceuticals in dense carbon dioxide, *Org. Proc. Res. Dev.* 4 (2000) 353-356.
- [10] V. Martinez, S. Mecking, T. Tassaing, M. Besnard, S. Moisan, F. Cansell, C. Aymonier, Dendritic core-Shell macromolecules soluble in supercritical carbon dioxide, *Macromolecules* 39 (2006) 3978-3979.
- [11] S. Fujita, S. Fujisawa, B.M. Bhanage, Y. Ikushima, M. Arai, Hydroformylation of 1,5-hexadiene catalyzed by rhodium complexes in supercritical carbon dioxide and in toluene: effects of fluorinated phosphane ligands and reaction conditions, *Eur. J. Org. Chem.* 13 (2004) 2881-2887.
- [12] S. Fujita, S. Fujisawa, B.M. Bhanage, M. Arai, Rhodium – tris (3,5-bis (trifluoromethyl) phenyl) phosphine catalyzed hydroformylation of dienes to dialdehydes in supercritical carbon dioxide with high activity, *Tetrahedron Lett.* 45

(2004) 1307-1310.

- [13] F. Zhao, Y. Ikushima, M. Chatterjee, O. Sato, M. Arai, Hydrogenation of an α,β -unsaturated aldehyde catalyzed with ruthenium complexes with different fluorinated phosphine compounds in supercritical carbon dioxide and conventional organic solvents, *J. Supercritical Fluids* 27 (2003) 65-72.
- [14] J. Chrastil, Solubility of solids and liquid in supercritical gases, *J. Phys. Chem.* 86 (1982) 3016-3021.
- [15] M. Yamamoto, Y. Iwai, T. Nakajima, Y. Arai, Fourier transform infrared study on hydrogen bonding species of carboxylic acids in supercritical carbon dioxide with ethanol, *J. Phys. Chem. A* 103 (1999) 3525-3529.
- [16] Y. Iwai, D. Tanabe, M. Yamamoto, T. Nakajima, M. Uno, Y. Arai, FT-IR study on interactions between solutes and entrainers in supercritical carbon dioxide, *Fluid Phase Equilibria* 193 (2002) 203-216.
- [17] Y. Iwai, M. Uno, H. Nagano, Y. Arai, Measurement of solubilities of palmitic acid in supercritical carbon dioxide and entrainer effect of water by FTIR spectroscopy, *J. Supercritical Fluids* 28 (2004) 193-200.
- [18] F.H. Huang, M.H. Li, L.L. Lee, K.E. Starling, F.T.H. Chung, An accurate equation of state for carbon dioxide, *J. Chem. Eng. Jpn.* 18 (1985) 490-496.

Table 1 Solubilities of ligands(2) in supercritical carbon dioxide(1)

Triphenylphosphine (TPP)					
T [K]	p [MPa]	y_2 [-]	T [K]	p [MPa]	y_2 [-]
320	8.96	0.000042	333	9.95	0.000039
	9.99	0.000190		10.55	0.000070
	10.96	0.000457		10.97	0.000095
	11.98	0.000685		11.49	0.000162
	13.99	0.000922		12.04	0.000228
	15.91	0.00109		12.50	0.000248
	17.76	0.00130		12.98	0.000340
				13.08	0.000443
				13.50	0.000462
				13.95	0.000558
				14.01	0.000648
				14.52	0.000776
				15.02	0.000870
				15.45	0.000949
				15.94	0.00102
Tris(<i>p</i> -trifluoromethylphenyl)phosphine (TTFMPP)					
T [K]	p [MPa]	y_2 [-]	T [K]	p [MPa]	y_2 [-]
320	9.01	0.000082	333	10.02	0.000094
	9.20	0.000143		10.50	0.000182
	9.39	0.000174		11.03	0.000303
	9.67	0.000425		11.47	0.000553
	9.77	0.000472		11.98	0.000925
	9.87	0.000628		12.44	0.001539
	10.14	0.000923		12.63	0.001869
	10.52	0.00254		12.75	0.00212
	10.67	0.00327		12.92	0.00241
	10.78	0.00377		13.05	0.00278
	10.92	0.00447		13.29	0.00339
				13.45	0.00384
				13.70	0.00450
				13.86	0.00491

Table 2 Solubilities of Rh complexes(2) in supercritical carbon dioxide(1)

Carbonylhydridotris(triphenylphosphine)rhodium (Rh-TPP)					
T [K]	p [MPa]	$y_2 \times 10^7$ [-]			
333	9.91	3.1			
	10.96	3.7			
	12.94	4.4			
	14.87	5.8			
	15.94	6.2			
	16.93	6.6			
Rh-TTFMPP					
T [K]	p [MPa]	$y_2 \times 10^5$ [-]	T [K]	p [MPa]	$y_2 \times 10^5$ [-]
320	9.04	0.44	333	12.02	0.12
	9.92	2.4		12.85	0.44
	10.96	9.9		13.77	1.1
	11.23	11.0		14.94	1.9
	11.90	14.0		15.30	2.0

Table 3 Increase ratios of metal complex(2) solubilities in supercritical carbon dioxide(1) by fluorination

Metal complex	y_2 [-]	T [K]	p [MPa]	Increase ratio of y_2
Rh(TPP)	5.8×10^{-7}	333	14.87	
Rh(TTFMPP)	1.9×10^{-5}	333	14.94	33
Na(DDC) [7]	1.0×10^{-5}	323	15.2	
Na(FDDC) [7]	3.1×10^{-5}	323	15.2	3.1
Cu(DDC) ₂ [7]	7.3×10^{-8}	323	15.2	
Cu(FDDC) ₂ [7]	6.1×10^{-5}	323	15.2	827
Ni(DDC) ₂ [7]	5.7×10^{-8}	323	15.2	
Ni(FDDC) ₂ [7]	4.8×10^{-5}	323	15.2	847
Co(DDC) ₃ [7]	1.6×10^{-7}	323	15.2	
Co(FDDC) ₃ [7]	5.3×10^{-5}	323	15.2	333
UO ₂ (ACAC) [9]	6.9×10^{-5}	313	15.0	
UO ₂ (TFA) [9]	3.8×10^{-4}	313	15.0	5.4

DDC: diethyldithiocarbamate, FDDC: bis(trifluoroethyl)dithiocarbamate, ACAC: acetylacetonate, TFA: trifluoroacetylacetonate

Table 4 Values of parameters k and C in Chrastil equation [14]

Solute	T [K]	k [-]	C [-]
TPP	320	4.72	- 29.6
	333	5.15	- 31.8
TTFMPP	320	7.98	- 47.3
	333	7.15	- 41.9
Rh-TPP	333	1.88	- 17.0
Rh-TTFMPP	320	6.27	- 39.2
	333	9.35	- 60.8

Figure Captions

Figure 1 Structural formulas of ligands: (a) Triphenylphosphine (TPP) , (b) Tris(*p*-trifluoromethylphenyl)phosphine (TTFMPP).

Figure 2 Structural formula of Rh complex.

Figure 3 Experimental apparatus for solubility measurement in supercritical carbon dioxide: 1. Gas Cylinder, 2. Dryer, 3. Filter, 4. Cooling Unit, 5. Feed Pump, 6. Safety Valve, 7. Preheating Coil, 8. Check Valve, 9. Circulation Pump, 10. FT-IR, 11. Equilibrium Cell, 12. Flexible Heater, 13. Trap, 14. Water Bath, 15. Pressure Meter, 16. Digital Pressure Meter, V2. Back Pressure Regulator, V11. Expansion Valve, V1,V3-V10. Stop Valve.

Figure 4 IR spectra of (a) TTFMPP at 320.0 K, (——— , , - - - - - : 10.14, 10.52, 10.92 MPa) and (b) Rh-TTFMPP at 320.0 K, (——— , , - - - - - : 9.92, 10.96, 11.90 MPa).

Figure 5 Absorbance variation as time for TPP in SCCO₂ at 333 K and 15.94 MPa: Absorbance at each time; (○), Averaged absorbance for determination of solubilities; (———).

Figure 6 Solubilities of phosphine ligands (2) in $\text{SCCO}_2(1)$: TPP(2); this work (\circ, \triangle : 320 and 333 K), Wagner et al. [7] (\bullet : 320 K), TTFMPP(2); this work (\square, ∇ : 320 and 333 K), Wagner et al. [7] (\blacksquare : 320 K).

Figure 7 Solubilities of Rh complexes(2) in $\text{SCCO}_2(1)$: Rh-TPP(2); (\circ : 333 K), Rh-TTFMPP(2); this work (\triangle, \square : 320 and 333 K).

Figure 8 Correlated results of solubilities of phosphine ligands(2) in $\text{SCCO}_2(1)$: Experimental data; TPP(2); (\circ, \triangle : 320 and 333 K), TTFMPP(2); (\square, ∇ : 320 and 333 K), Correlated results (——).

Figure 9 Correlated results of solubilities of Rh complex ligands(2) in $\text{SCCO}_2(1)$: Experimental data; Rh-TPP(2); (\circ : 333 K), Rh-TTFMPP(2); this work (\triangle, \square : 320 and 333 K), Correlated results (——).

(a)

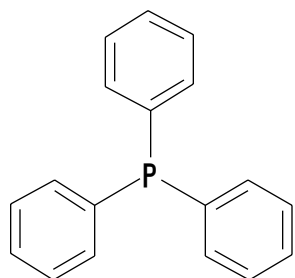

(b)

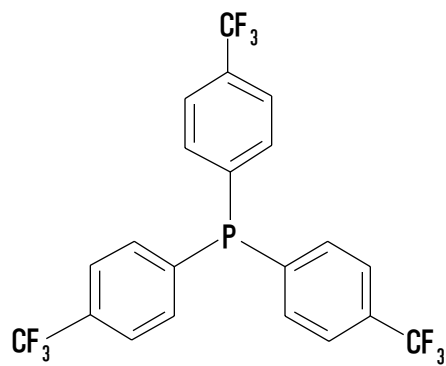
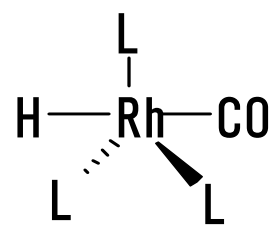

Figure 1



L: ligand

Figure 2

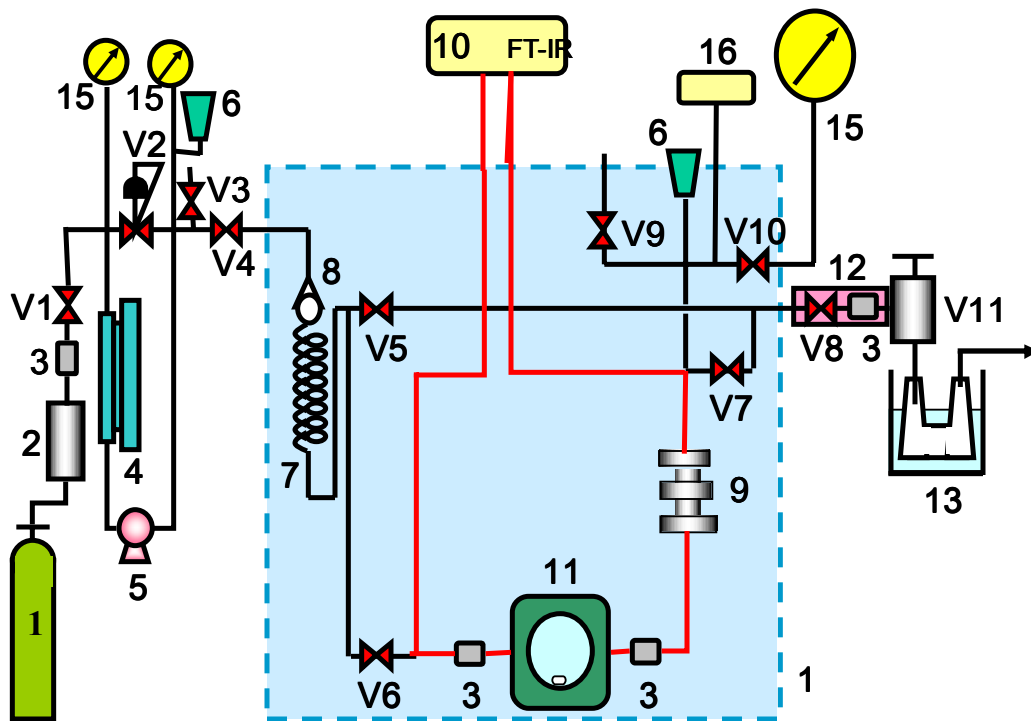

Figure 3

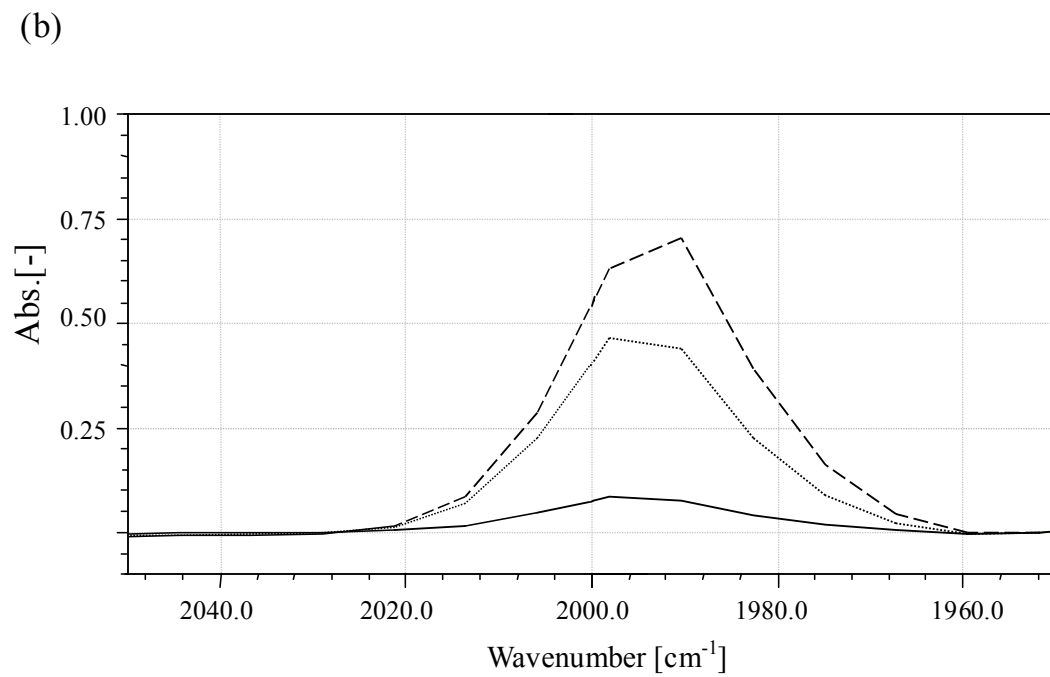
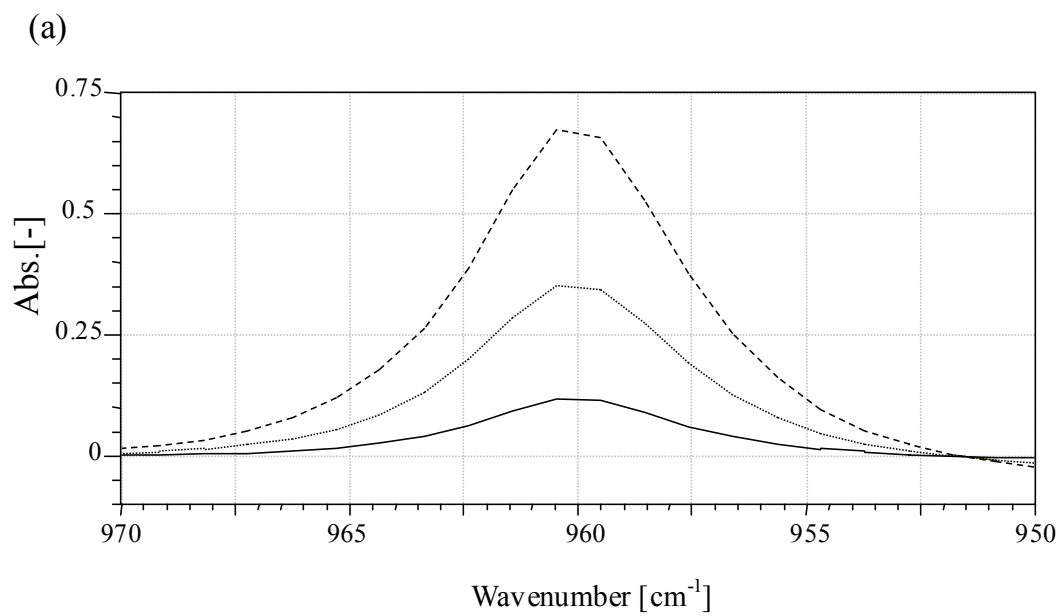

Figure 4

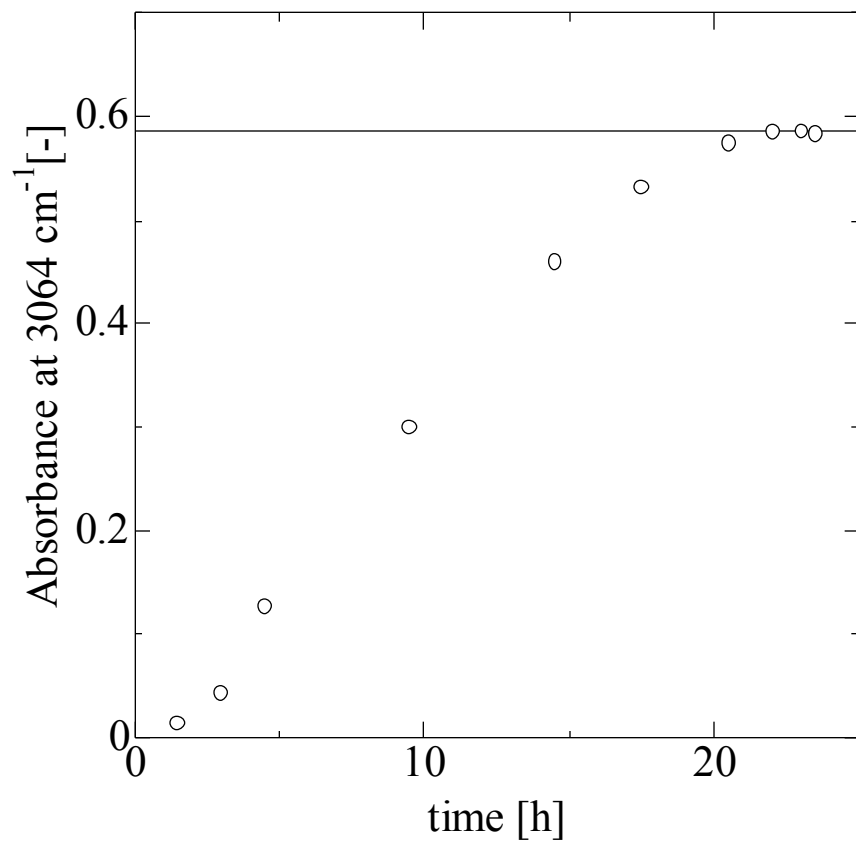

Figure 5

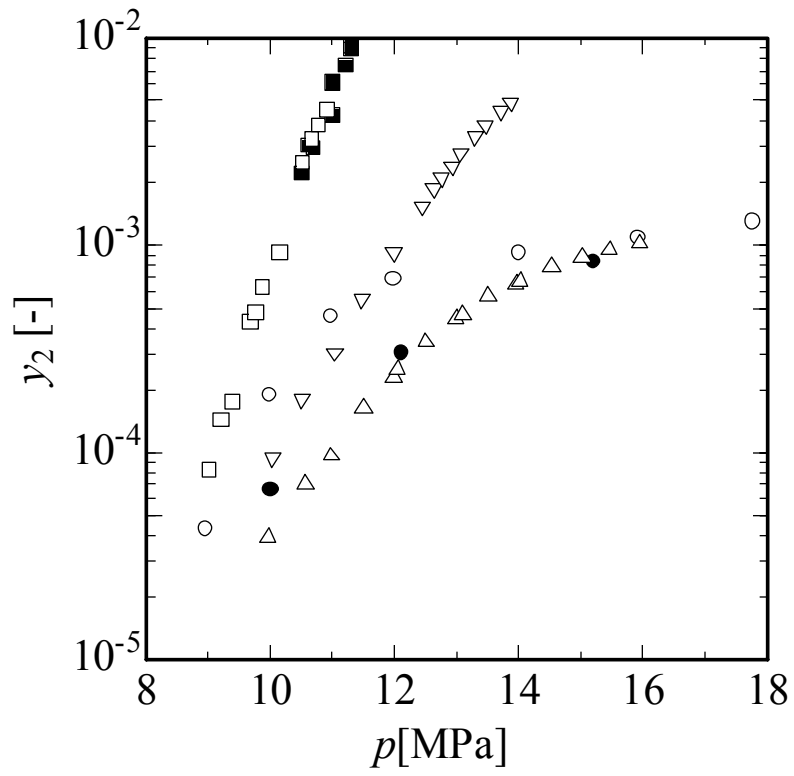

Figure 6

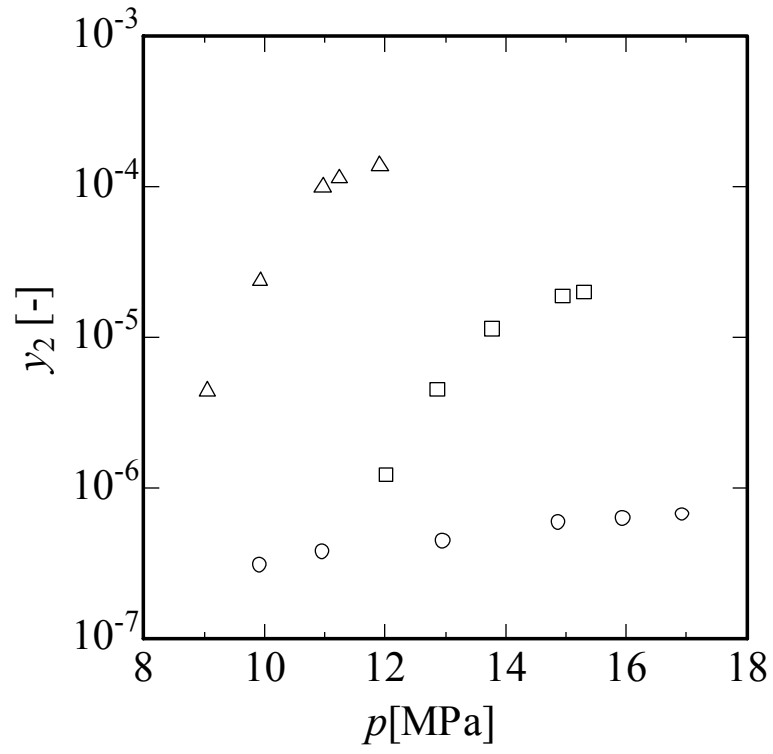

Figure 7

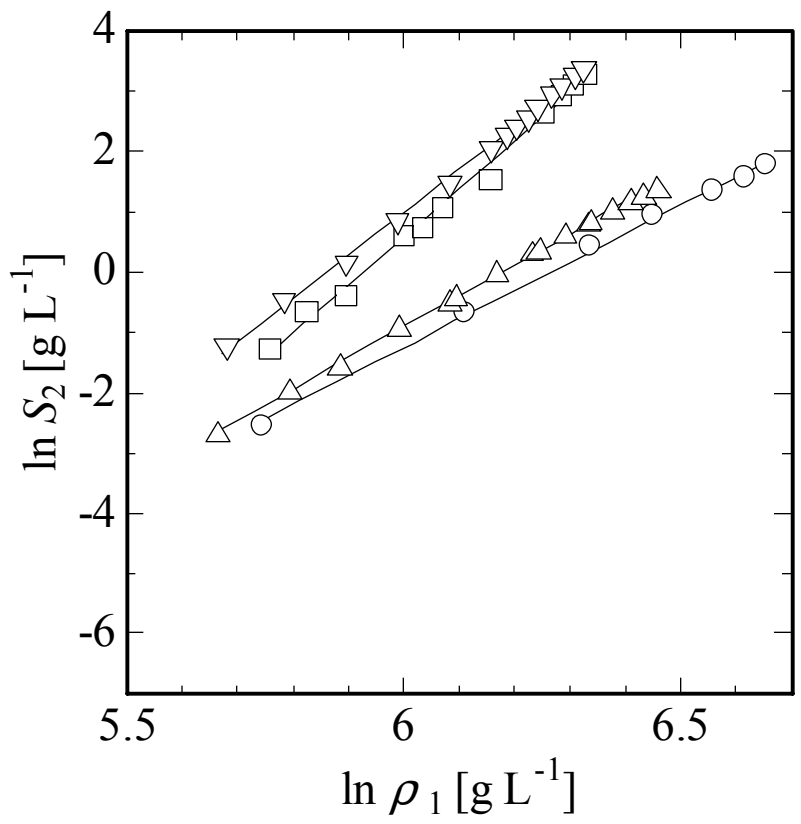

Figure 8

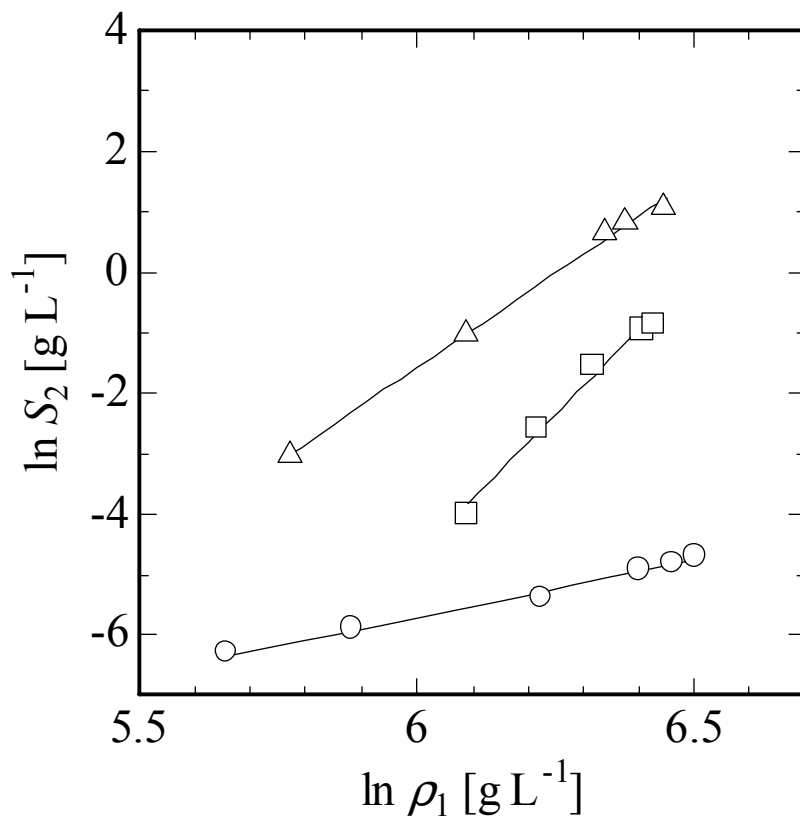

Figure 9