

Development of a magnetic field measurement system using a tri-axial search coil

著者	Tosaka Toshihide, Nagano Isamu, Yagitani Satoshi
journal or publication title	IEEE International Symposium on Electromagnetic Compatibility
volume	1
page range	102-106
year	2005-01-01
URL	http://hdl.handle.net/2297/6704

Development of a Magnetic Field Measurement System using a Tri-axial Search Coil

Toshihide Tosaka

National Institute of Information
and Communications Technology,
Wireless Communications Department
Email: tosaka@nict.go.jp

Isamu Nagano

Graduate School of Natural Science
and Technology, Kanazawa University
nagano@reg.is.t.kanazawa-u.ac.jp

Satoshi Yagitani

Graduate School of Natural Science
and Technology, Kanazawa University
yagitani@reg.is.t.kanazawa-u.ac.jp

Abstract— In order to measure the magnetic field noise around electric devices, we developed a measurement system using a tri-axial search coil. The crosstalk of the orthogonal search coils is less than -40 dB between the tri-axial search coil sensors. The measured magnetic sensitivity of the search coil is 10 pT/ $\sqrt{\text{Hz}}$ at 1 kHz.

I. INTRODUCTION

Recently, the use of electromagnetic waves is increasing in the technologies of electronics, information, and communications. It is believed that electromagnetic waves leaking from some electric devices may cause incorrect operation of other electric devices and may have some influence on a human's body. Therefore, we have to prevent these electromagnetic noises from affecting devices or our body, and it is necessary to shield out the magnetic field. We can prevent these electromagnetic noises using the shielding materials. But if we do not know the strength of the magnetic field that is leaking from the electric devices, we can not effectively prevent the noises. Therefore, we have to develop the shielding sheets considering these things so that they are appropriate for the purpose at hand.

Many sensors exist to measure the magnetic field, and some have been applied to observations from spacecraft [1] [2]. The GEOTAIL spacecraft was equipped with a search coil which we developed for measurement of plasma waves in the geomagnetosphere. The tri-axial search coil consists of three orthogonal search coils. But for the case of measurement of the magnetic field around electrical equipment, it does not have enough spatial resolution for the required measurement.

For these reasons, we developed a magnetic field measurement system that uses a small tri-axial search coil. We made a tri-axial search coil where the length of each search coil sensor is less than 5cm, and the magnetic sensitivity of the search coil is of the order of pico Tesla. Then, we evaluated it, and measured the magnetic field of a hair dryer, a microwave oven, a television, and an IH cooker following the directions of IEC 62233 [3]. Finally, we compared the measured values with ICNIRP [4] guidelines and confirmed whether or not the items met the guidelines.

II. SEARCH COIL

We chose the parameters of the search coil considering the measurement frequency is less than 100 kHz, and the magnetic sensitivity of the search coil is of the order of pico Tesla. These choices were because we intended for electric equipment to measure a magnetic field. The search coil is a circular cylinder whose length is 35 mm and diameter is 3.5 mm. The core which we used for the search coil has an effective permeability [5] of 56.2. The effective permeability relates to the length and diameter of the core [6]. Other parameters of the search coil are shown in table I. We made the search coil as shown in fig. 1. This search coil was covered with shielding tape for electrostatic shielding. We made three search coils. Then, we constructed the triaxial search coil shown in fig. 2 where each coil is orthogonal to the other two. Fig. 3 shows the equivalent circuit of the measurement system of the magnetic field which we developed that includes the thermal noises. We used an AMP01 which is a differential amplifier that has very low noise.

The inductive voltage of the coil, V_s , and the output voltage of the pre amp, V_o , are calculated as shown in the equations below.

$$\begin{aligned} V_s &= GfB[nT] \times 10^{-6} \\ V_o &= KV_s \end{aligned}$$

In here, G is the Gain factor that is defined by the shape of the search coil ($G = 2\pi\mu NS \times 10^{-3}$). Here, f is the frequency, B is the magnetic flux density, and K is the system gain that is defined as shown in the equations below.

$$K = \frac{A}{\frac{r}{R} + 1 - \omega^2 CL + j\omega(\frac{L}{R} + Cr)}$$

III. EVALUATION OF THE SEARCH COIL

For measurement of the magnetic field, we have to evaluate the search coils. In this section, we evaluate the measurement magnetic sensitivity and crosstalk of the tri-axial search coil which we constructed.

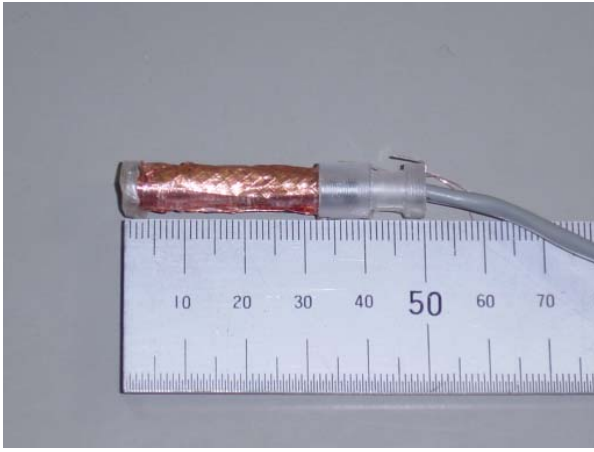

Fig. 1. Search coil

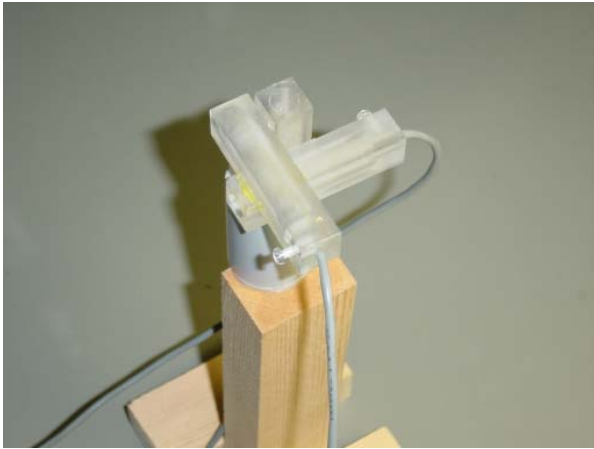

Fig. 2. Constructed tri-axial search coil

A. Amplitude characteristics and maximum sensitivity

For calibration of the search coil, we used a shield box. The coil is placed inside of the shield box and by using this shield box, we can observe a uniform magnetic field. The magnetic flux at the center position of the shield box is 1 nT per volt. Fig. 4 shows the frequency characteristics of the output voltage V_o in fig. 3. The line shows the calculated values and the symbols show the measured values. The frequency characteristics of the magnetic sensitivity of the search coil are shown fig. 5. The magnetic sensitivity is defined as shown in the following equation.

$$F_H = \frac{B[\text{nT}]}{\sqrt{\Delta f}} \cdot \frac{E_N}{V_s} [\text{nT}/\sqrt{\text{Hz}}]$$

$$E_N^2 = E_{N_1}^2 + E_{N_2}^2 \frac{(r^2 + \omega^2 L^2)}{R^2} + E_{N_3}^2 \frac{[\{r + R(1 - \omega^2 LC)\}^2 + (\omega L + \omega C R r)^2]}{R^2} + I_N^2 (r^2 + \omega^2 L^2)$$

Here, f is the bandwidth, E_N is the noise voltage at the

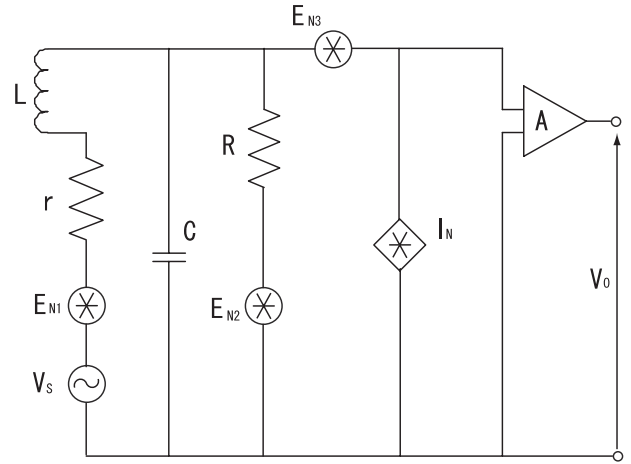

Fig. 3. Equivalent circuit

TABLE I
PARAMETERS OF SEARCH COIL

Resistance of search coil : r	22 [Ω]
Inductance : L	4.65 [mH]
Stray capacitance : C	54.0 [pF]
Turns : N	500
Diameter of the copper wire	0.06 [mm]
Damping resistance : R	3k [Ω]
Voltage noise : E_N	5 [nV/ $\sqrt{\text{Hz}}$] ($f > 10$ Hz)
Current noise : I_N	0.12 [pA/ $\sqrt{\text{Hz}}$] ($f > 10$ Hz)
Gain factor : G	0.17
Gain of Pre Amp : A	40

V_s point, and the subscripted E_N shows the thermal noise of each resistance.

From these figures, we can measure to the order of 10 pT/ $\sqrt{\text{Hz}}$ at 1 kHz. We measured the amplitude characteristics and the magnetic sensitivity for all the search coils, and the results were the same as shown in figs. 4 and 5.

B. Effect of crosstalk among the search coils

If crosstalk happens such that one axis of the search coil exerts an influence on another axis, we can not measure the magnetic field correctly using the tri-axial search coil. In order to measure the effect of crosstalk of the tri-axial search coil, we used a Helmholtz coil. The Helmholtz coil which we made had a diameter of 20 cm, 5 turns, and a current of 30 mA. For this situation, a field of 675 nT occurs at the center of the Helmholtz coil. The magnetic field error at the center of the straight line of between these coils including ± 4 cm is less than 1 %. Fig. 6 shows the frequency characteristics of V_o for each axis of the search coils. Here the x-axis is parallel to the direction of the magnetic field, and the other axes (y-axis and z-axis) are perpendicular to the magnetic field. From this figure, we found the difference between the x-axis and other axes was more than -40 dB. Then we measured the y-axis and the z-axis, and the results were the same as the x-axis situation. From these results, we found we can ignore the effect of crosstalk among the tri-axial search coil sensors.

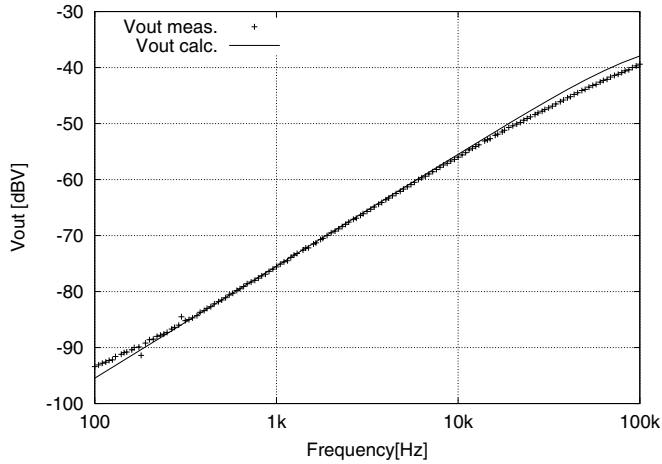

Fig. 4. Amplitude characteristics for pre amp

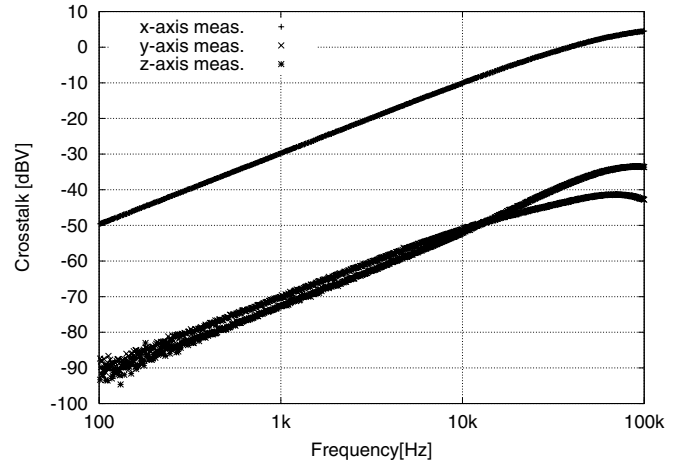

Fig. 6. Crosstalk of tri-axial search coil

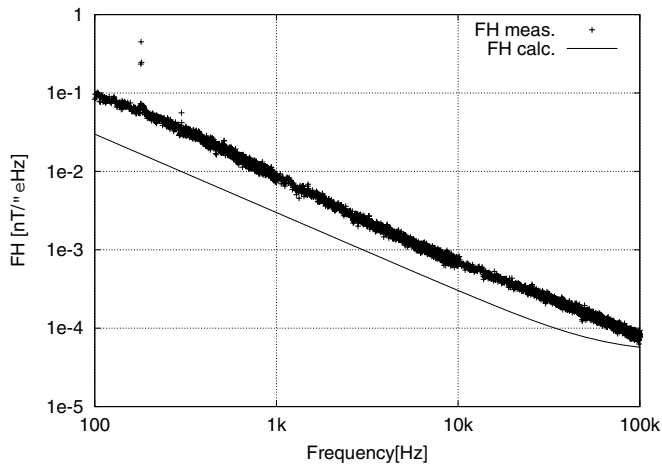

Fig. 5. Maximum magnetic sensitivity

IV. MEASUREMENT OF MAGNETIC FIELD

From previous sections, we found that our tri-axial search coil does not have a crosstalk problem and we can measure the magnetic field with high accuracy. In this section, we will report the magnetic field of electronic equipment. For measurement, we used a spectrum analyzer and measured a hair dryer, a microwave oven, a television, and an IH cooker. The measurement distance from the electric equipment to the tri-axial search coil is different, and that is according to what is written in IEC 62233. Therefore, we followed the IEC 62233 guidelines in order to measure the magnetic field. At first, we measured at the applicable position and applicable distance stated in IEC 62233. Then, we measured at the strongest position of the magnetic field.

These figures show the coordinate systems of the electric equipment which we used to measure the magnetic field. The circle symbols in the figures show the points of measurement based on IEC 62233. The star symbols in the figures show the strongest position of the magnetic field.

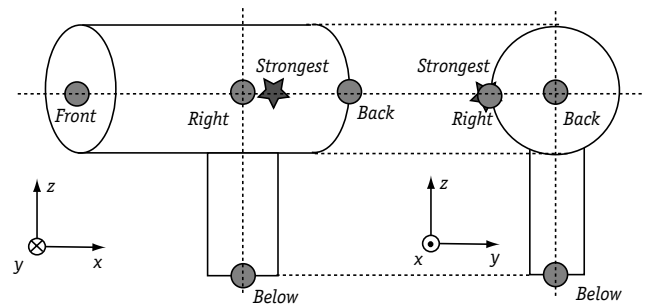

Fig. 7. The coordinate axes of a Hair dryer

A. Position based on IEC 62233

The measurement positions of the electric equipment are the right side, left side, front side, back side, overhead location, and under the center position of the noise source point. Different measurement positions are stated for different electric equipment for. For the case of a hair dryer, the stated measurement positions are the right, left, front, and back sides. But for the case of a microwave oven, they are the front side and overhead. For the case of a television, only the front side position is stated. For the case of an IH cooker, the right, left, front, and back sides are stated. The distance from the tri-axial search coil to the chassis of electric equipment such as a hair dryer, a microwave oven, and an IH cooker, is 30 cm, and for a television it is 50 cm. The frequency of the strongest point of the noise spectrum for a hair dryer is 1.48 kHz, 35 to 53 kHz for a microwave oven, 15.6 kHz for a television, and 22.8 kHz for an IH cooker. Then, we measured the magnetic field at the defined position of each axis. The results of the measured values are shown in tables II, III, IV, V.

B. The strongest position

For the case of the strongest position of the magnetic field, the measured distances from the tri-axial search coil to the surface of the electric equipment are 5 cm, 10 cm, 30 cm, and

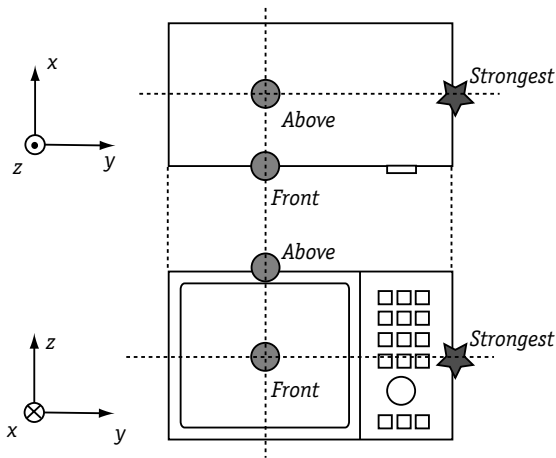

Fig. 8. The coordinate axes of a microwave oven

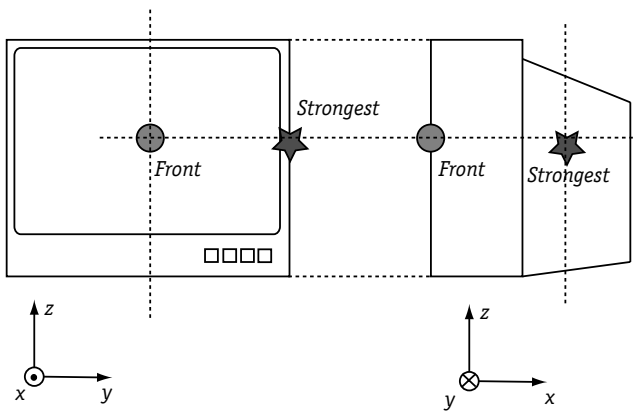

Fig. 9. The coordinate axes of a television

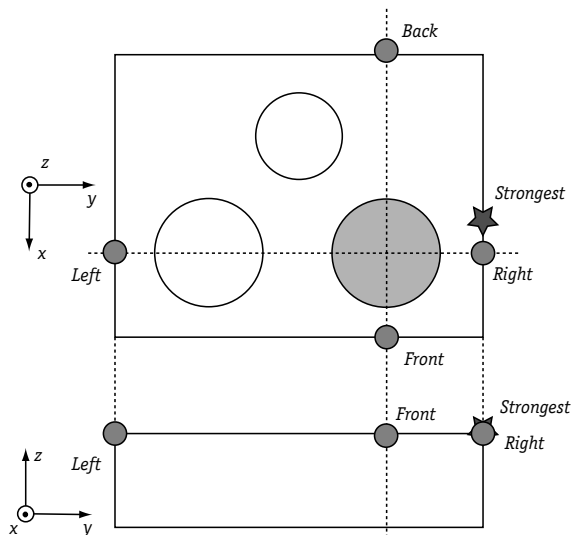

Fig. 10. The coordinate axes of an IH cooker

TABLE II
HAIR DRYER (1.48 KHZ)

Position	x-axis	y-axis	z-axis	Magnitude
Right side	7.94 nT	22.4 nT	4.47 nT	24.2 nT
Below side	0.40 nT	15.8 nT	5.62 nT	16.8 nT
Back side	1.25 nT	11.2 nT	1.78 nT	11.4 nT
Front side	0.56 nT	8.91 nT	1.25 nT	9.01 nT

TABLE III
MICROWAVE OVEN (35-53 KHZ)

Position	x-axis	y-axis	z-axis	Magnitude
Front side	100 nT	126 nT	50.1 nT	168.5 nT
Above side	89.1 nT	35.5 nT	79.4 nT	124.5 nT

TABLE IV
TELEVISION (15.6 KHZ)

Position	x-axis	y-axis	z-axis	Magnitude
Front side	4.47 nT	2.24 nT	3.55 nT	6.13 nT

TABLE V
IH COOKER (22.8 KHZ)

Position	x-axis	y-axis	z-axis	Magnitude
Right side	305 nT	653 nT	367 nT	808.8 nT
Left side	92.3 nT	119 nT	50.0 nT	158.7 nT
Front side	272 nT	108 nT	543 nT	616.8 nT
Back side	347 nT	39.0 nT	155 nT	382.0 nT

50 cm. And we measured the magnetic field along each axis of the tri-axial search coil. The results of the measured values are shown in tables VI, VII, VIII, IX.

C. Results and their evaluation

We measured the magnetic field for four types of electric equipment. Apart from table VIII, as the distance from the search coil to the electric equipment becomes longer, the measured magnetic field becomes smaller. But for the case of the z-axis at 10 cm in table VIII, the magnetic field became larger. The square root of the sum of the squares for the three axes at 5 cm in table VIII is larger than that at 10 cm in table VIII. There are many sensors for magnetic field measurements available commercially. However, if we used these sensors, we could not find that the magnetic field strength is different for any axis because these sensors only display the square root of the sum of the squares value of the magnetic field. For these reasons, we have to measure the magnetic field in three dimensions with instruments such as the tri-axial search coil that we used.

Then we evaluated the electric equipment which we measured. In order to evaluate, we used the ICNIRP guideline [4]. The ICNIRP guideline was established in 1998. This guideline states the exposure limitation of the electric field and the magnetic field. It is written for the cases of general public exposure limitation and occupational exposure limitation up to 300 GHz. For the case of general public exposure, the limitation is $6.28 \mu\text{T}$, and for the case of occupational exposure, the limitation is $30.7 \mu\text{T}$. In order to compare these values, we

TABLE VI
HAIR DRYER (1.48 KHZ)

Distance	x-axis	y-axis	z-axis	Magnitude
5 cm	355 nT	3160 nT	200 nT	3186.2 nT
10 cm	31.6 nT	281 nT	28.2 nT	284.2 nT
30 cm	2.24 nT	28.2 nT	2.24 nT	28.4 nT
50 cm	0.40 nT	5.01 nT	0.63 nT	5.07 nT

TABLE VII
MICROWAVE OVEN (35-53 KHZ)

Distance	x-axis	y-axis	z-axis	Magnitude
5 cm	1780 nT	1580 nT	1260 nT	2693.0 nT
10 cm	1260 nT	1260 nT	794 nT	1950.8 nT
30 cm	158 nT	178 nT	70.8 nT	248.3 nT
50 cm	79.4 nT	63.1 nT	35.5 nT	107.5 nT

TABLE VIII
TELEVISION (15.6 KHZ)

Distance	x-axis	y-axis	z-axis	Magnitude
5 cm	44.7 nT	70.8 nT	70.8 nT	109.7 nT
10 cm	15.8 nT	70.8 nT	79.4 nT	107.5 nT
30 cm	10.0 nT	63.1 nT	25.1 nT	68.8 nT
50 cm	1.12 nT	28.2 nT	20.0 nT	34.6 nT

TABLE IX
IH COOKER (22.8 KHZ)

Distance	x-axis	y-axis	z-axis	Magnitude
5 cm	4370 nT	17800 nT	8320 nT	20128.6 nT
10 cm	2190 nT	7410 nT	3980 nT	8691.6 nT
30 cm	339 nT	589 nT	676 nT	958.5 nT
50 cm	204 nT	129 nT	123 nT	270.9 nT

calculated the magnitude from the square root of the sum of the squares of the three axes, and then we compared the results of the calculation at the strongest position with the value of the ICNIRP guideline. The magnitude calculated from the square root of the sum of the squares value is $3.19 \mu\text{T}$ for a hair dryer, $2.69 \mu\text{T}$ for a microwave oven, $0.11 \mu\text{T}$ for a television, and $20.1 \mu\text{T}$ for an IH cooker. From these results, except for the IH cooker, these measured values are less than the ICNIRP guideline. But for the case of the IH cooker, the measured value is greater than the ICNIRP guideline. Therefore, we have to consider how to protect an IH cooker user such as by using shielding techniques.

V. CONCLUSION

The purpose of our research was developing a tri-axial search coil and measuring the magnetic field around electric equipment. First we made a tri-axial search coil that could measure to the order of pico Tesla without crosstalk. Then we measured the magnetic field around the electric equipment. As the distance from the electric equipment to the tri-axial search coil becomes longer, the square root of the sum of the squares of the magnetic field components is smaller. But the view from three dimensions is not possible considering only the magnitude. For these reasons, we have to measure in three dimensions using a tri-axial search coil which we made.

Then, we compared the measured value with the guideline value. From the results, we found an IH cooker emitted a strong magnetic field, and we have to find a way to reduce the emitted field for the electric equipment where the magnetic field value is larger than guideline values.

We developed a tri-axial search coil. We hope this technique will be useful for EMC measurements and to solve EMC problems.

REFERENCES

- [1] I. Nagano, M. Tsutsui, T. Okada, H. Kojima, H. Matsumoto, S. Yagitani, and Y. Sato "Characteristics of Tri-axial Search Coil Sensor on Board the GEOTAIL Spacecraft" IEICEJ Tech. Report, pp. 31-38, Jan., 1995.
- [2] H. Matsumoto, I. Nagano, R. R. Anderson, H. Kojima, K. Hashimoto, M. Tsutsui, T. Okada, I. Kimura, Y. Omura, and M. Okada "Plasma Wave Observation with GEOTAIL Spacecraft" J. Geomag. Geoelectr., vol. 49, 59-95, 1994.
- [3] "Measurement methods for low frequency magnetic and electric fields of domestic appliances with regard to human exposure" IEC 62233
- [4] "Guideline for limiting exposure to Time-Varying electric, magnetic. And electromagnetic fields (Up to 300 GHz), " *International Commission on Non-Ionizing Radiation Protection*, Apr. 1998.
- [5] H. Yamada, E. Miyazawa, and K. Bessyo "Magnetics Fundamentals" Gakukensya, Apr., 1975.
- [6] J. S. Belrose "Ferromagnetic Loop Aerials for kirometric waves" Wireless Engineer, pp. 41-46, Feb., 1955.