

Fluctuation of Resonance Frequency of Applicator Having Wireless Power Transmission for Hyperthermia Therapy

著者	Yamada Sotoshi, Ikehata Yoshio, Ueno Toshiyuki, Kakikawa Makiko
journal or publication title	Journal of the Magnetics Society of Japan
volume	37
number	3-2
page range	282-286
year	2013-01-01
URL	http://hdl.handle.net/2297/37002

doi: 10.3379/msjmag.1305R010

Fluctuation of Resonance Frequency of Applicator Having Wireless Power Transmission for Hyperthermia Therapy

S. Yamada, Y. Ikehata, T. Ueno*, and M. Kakikawa

Institute of Nature and Environmental Technology, Kanazawa Univ., *Kakuma-machi, Kanazawa 920-1192, Japan*

*Graduate School of Nature and Technology, Kanazawa Univ., *Kakuma-machi, Kanazawa 920-1192, Japan*

One of the hyperthermia therapies is high-frequency induction heating type by using nano-magnetic materials and magnetic implants. A tumor with injected magnetic materials is heated by hysteresis loss and eddy-current loss under high frequency magnetic fields with a few hundred kHz. To generate magnetic fields at the deep position of a body, we proposed a double pancake type exciting system with wireless power transmission. Since this system is constituted by two tuned resonant circuits, the characteristic is sensitive to the change of parameters.

This paper discusses the fluctuations of resonance frequency depending on the change of a distance between the exciting and induced coils and resonance capacitor. As a result, we recognized the fluctuation range of the resonance frequency for a tuned exciting power source.

Key words: hyperthermia, applicator, pancake coil, wireless transmission, resonance frequency, fluctuation

1. Introduction

Hyperthermia therapy is a low-invasive target treatment that carries out apoptosis or necrosis on cancer tumor¹⁾. The tumor with injected magnetic materials can be heated by hysteresis and eddy-current losses under external high frequency magnetic fields with more than $200 \text{ kHz} \times \text{mT}$ ²⁾⁻⁴⁾. There are two types of applicators (exciting coils), solenoidal coil and flat coil to generate magnetic fields for hyperthermia. On the former system, a body is located inside of the exciting coil. The magnitude of magnetic fields is relatively uniform at both skin and deep position of body. But the size of coil and an apparent power capacity become large. On the latter, the flat coil is located on the surface of body and the structure does not depend on the size of body strictly. However it is difficult to generate uniform and high magnetic fields on tumors of deep position.

We proposed the double pancake type exciting system with two flat coils sandwiching body. The exciting system does not restrict flexibility of a flat coil and improves the attenuation of magnetic fields far from an exciting coil. But two pancake coils installed separately should be series-connected in the situation where huge current flows. In this case, an input voltage becomes larger and the connection line also needs to be cooled. Then, it is inconvenient to set a patient between two coils. We applied wireless power transfer system to the excitation of double pancake coils, that is, one is the exciting coil and the other is induced coil. Two coils without physical connection enable us to install the applicator to a patient more easily. We can offer a gentle operating environment to a patient. On the other hand, since two coils are not fixed mutually, electromagnetic coupling of coils, actually mutual

inductance, changes to the fluctuation of a position. We analyzed the fluctuation of mutual inductance values depending on the position movement and discussed the characteristics of the system based on the equivalent circuit. Further, the influence on change of the resonance capacitor by operating temperature was also evaluated.

2. Applicator with wireless transmission system

2.1 Double pancake type applicator

An applicator is installed outside of a body to heat magnetic implant and magnetic particles based on eddy-current and hysteresis losses. We introduce the double pancake exciting system with two flat spiral coils as shown in Fig. 1. Two coils sandwich a body and generate magnetic fields on both upper and lower

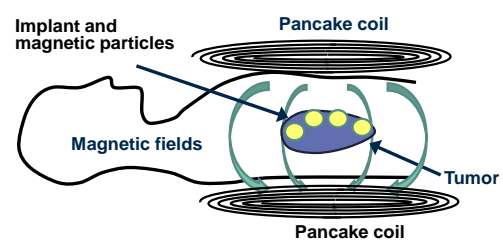

(a) Outline of the system

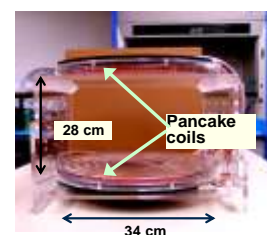

(b) Model with practical size

Fig. 1 Double pancake type applicator.

sides. The distribution becomes flat and smooth near the center of two coils (deep position). Both coils are series-connected to flow current with the same frequency and phase, then the exciting power source needs 2-4 times apparent power as much as a single coil. The connection cable among two coils increases inductance and losses. Furthermore, the structure brings a problem to cooling mechanism and the installation of patient at an operation.

We apply a wireless transmission system to the excitation of double pancake coils⁵⁾. One of pancake coils operates as exciting coil and current is induced on the other coil. Fig. 2 shows the outline of applicator with double pancake coils by a wireless transmission system. The upper coil with series capacitor is connected to a high frequency power source directly and the lower pancake coil is connected to a resonance capacitor. Both coils are connected by magnetic coupling. The system gives the flexibility of coil gap and position to install a patient at an operation bed. Moreover, it is easy to arrange the distance of pancake coils according to bodily size and to align a position as shown in Fig. 3.

But the coupling condition, mutual inductance, depending upon the distance between two pancake coils remarkably affects the effect of resonance frequency and wireless transmission. We must recognize the fluctuation of mutual inductance depending upon the relative position of two coils. Otherwise, although there is a fluctuation of mutual inductance by the difference of two coils in structure, we do not discuss as a small effect.

2.2 Equivalent circuit and characteristics

We derive the equivalent circuit in order to analysis the performance of the pancake coils with

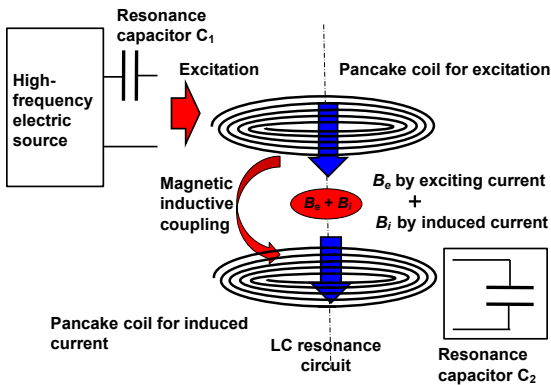
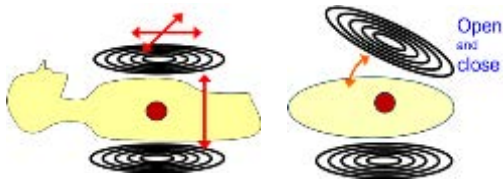
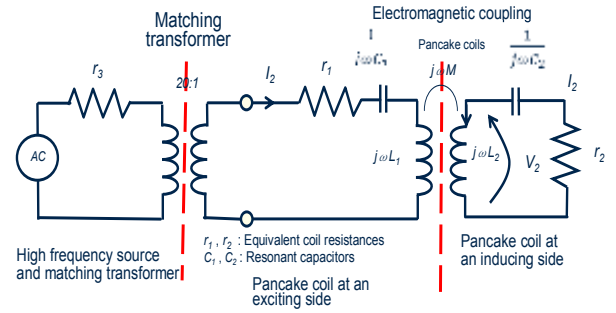

Fig. 2 Applicator with wireless transmission system.



(a) Change of position (b) Change of inclination

Fig. 3 Position fluctuation of pancake coils.



(a) Circuit of the system

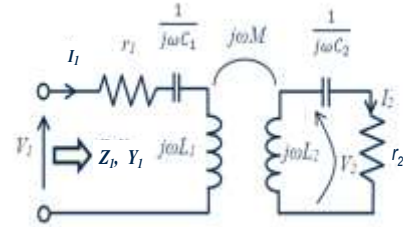

(b) Equivalent circuit

Fig. 4 Applicator with wireless transmission system.

wireless transmission in Fig. 4(a)⁶⁾. When an exciting frequency is about some hundred kHz, we neglect the displacement currents and consider only the magnetic coupling between coils. Fig. 4(b) shows the equivalent circuit connected with resonance capacitors. The primary side is the exciting part and the secondary side is the induced part. The applicator system has no load but there are losses in coils and wires expressed by resistances, r_1 and r_2 .

When the phasor analysis is applied to the equivalent circuit in Fig. 4(b), the primary and secondary currents I_1 , I_2 are given by,

$$I_1 = \dot{V}_1 / \dot{Z}_1 \quad (1)$$

$$\dot{Z}_1 = \left\{ r_1 + \frac{\omega^2 M^2 r_2}{r_2^2 + (\omega L_2 - \frac{1}{\omega C_2})^2} \right\} + j \left\{ (\omega L_1 - \frac{1}{\omega C_1}) - \frac{\omega^2 M^2 (\omega L_2 - \frac{1}{\omega C_2})}{r_2^2 + (\omega L_2 - \frac{1}{\omega C_2})^2} \right\} \quad (2)$$

$$\dot{I}_2 / \dot{I}_1 = \frac{j \omega M \left\{ r_2 - j (\omega L_2 - \frac{1}{\omega C_2}) \right\}}{r_2^2 + (\omega L_2 - \frac{1}{\omega C_2})^2} \quad (3)$$

On the design, the L-C parameters at the exciting and induce circuits has the same resonance frequency f_0 , that is,

$$f_0 = 1 / 2\pi \sqrt{L_1 C_1} = 1 / 2\pi \sqrt{L_2 C_2} \quad (4)$$

We fabricated the double pancake coils suited for human body size as shown in Fig. 1(b). The outer diameter of pancake coil is 340 mm. The pancake coil is made of Ritz wire with 60 μm in diameter and 6,000 lines. We list the parameters of pancake coil as ring coils modeled in Fig. 5. The ring coils with 5 turns are series-connected and the distance between two pancake coils are 280 mm. The structure parameters of pancake coil are listed in Table 1. The distance fills the thickness of Japanese's breast up to 95 %⁷⁾. The measured circuit parameters are listed in Table 2.

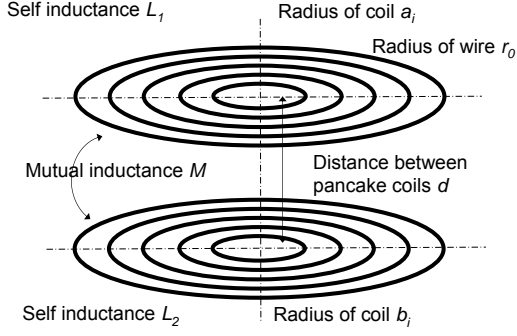

Fig. 5 Model of double pancake coils with ring structure.

Table 1 Structure of pancake coils.

Ring coils	No.1	No.2	No.3	No.4	No.5
a_i, b_i (mm)	70	90	120	145	170
r_0 (mm)	5	5	5	5	5
Distance of pancake coil d (mm)	280				

Table 2 Measured circuit parameters.

	Exciting side	Induced side
Capacitor C_1, C_2 (μF)	0.29	0.32
Inductance L_1, L_2 (μH)	6.44	5.88
Q-value Q_1, Q_2	366	471
Resistance r_1, r_2 (m Ω)	12.9	9.5
Mutual inductance M (μH)	0.407	

According to the experiments, the frequency characteristics on the exciting and induced circuit are shown in Fig 6. We observed two resonance frequencies (f_1 and f_2). The resonance frequency of the L-C circuit by Eq. (4) is between these frequencies. The resonance frequencies, f_1 and f_2 , are expressed by,

$$f_1 = \frac{1}{2\pi\sqrt{C_1(L_1 + M)}}, \quad f_2 = \frac{1}{2\pi\sqrt{C_2(L_2 - M)}}. \quad (5)$$

It is remarkable that the exciting and induced currents have the same amplitude near two resonance frequencies. Two pancake coils have almost the same inductance and the same resonance frequency f_0 . Then, Eq. (3) at both frequencies, $\omega_1 (=2\pi f_1)$ and $\omega_2 (=2\pi f_2)$, is derived by

$$\left| \frac{i_2}{i_1} \right| = \frac{\omega_1 M}{\sqrt{r_1^2 + \left(\omega_1 L - \frac{1}{\omega_1 C}\right)^2}} \approx \frac{\omega_1 M}{\omega_1 C - \omega_1 L} = 1 \quad (\omega_1 = 2\pi f_1), \quad (6)$$

$$\left| \frac{i_2}{i_1} \right| = \frac{\omega_2 M}{\sqrt{r_2^2 + \left(\omega_2 L - \frac{1}{\omega_2 C}\right)^2}} \approx \frac{\omega_2 M}{\omega_2 L - \frac{1}{\omega_2 C}} = 1 \quad (\omega_2 = 2\pi f_2), \quad (7)$$

where $L=L_1 \doteq L_2$, $C=C_1 \doteq C_2$, and

$$\frac{1}{\omega_1 C} > \omega_1 L, \quad \left(\frac{1}{\omega_1 C} - \omega_1 L\right) \gg r_1, \quad \omega_1 = \sqrt{\frac{1}{C(L+M)}} \quad (\omega_1 = 2\pi f_1), \quad (8)$$

$$\frac{1}{\omega_2 C} < \omega_2 L, \quad \left(\omega_2 L - \frac{1}{\omega_2 C}\right) \gg r_2, \quad \omega_2 = \sqrt{\frac{1}{C(L-M)}} \quad (\omega_2 = 2\pi f_2). \quad (9)$$

Therefore, the ratio I_1 / I_2 is about one to any value of mutual inductance near the frequencies, f_1 and f_2 .

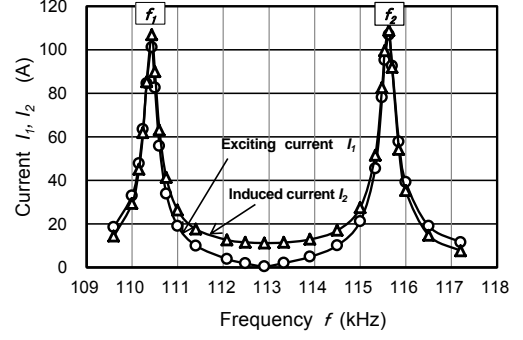

(a) Currents of exciting I_1 and induced currents I_2

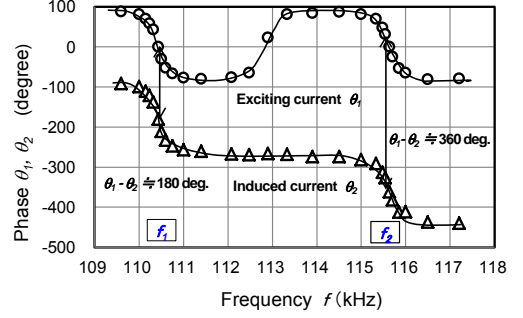

(b) Phase of exciting I_1 and induced currents I_2

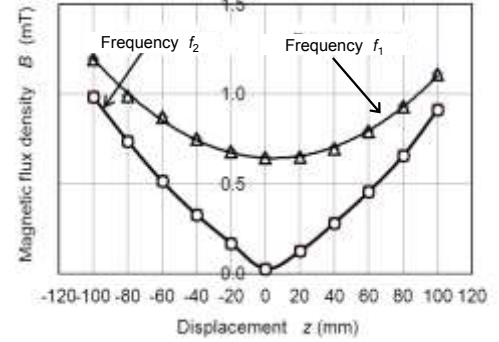

(c) Magnetic flux density along z -axis at two resonance frequencies

Fig. 6 Characteristics of currents and magnetic field distribution.

The phase difference between the exciting and induced currents is approximately π at the frequency f_1 , and 2π at f_2 as shown in Fig. 6(b). Then the currents, I_1 and I_2 flow so that the magnetic fields act as addition at f_1 . On the contrary, the magnetic fields induced by two pancake coils are canceled mutually at f_2 . Fig. 6(c) shows the magnetic field distribution on the z axis. The magnetic fields by two coils are added at f_1 on the center $z = 0$, but subtracted at f_2 . On the applicator system, the exciting frequency is adjusted at f_1 corresponding to the fluctuation of circuit parameters.

If pancake coils are adjusted to a body of patient and targeted to the position of tumor as shown in Fig. 3, a mutual inductance between two coils is changed slightly and then the frequency f_1 is altered. The recognition of the fluctuation of the resonance frequency is important for a high frequency electric source with variable frequency.

3. Fluctuation of resonance frequency

3.1 Distance of two coils

The distance influences a mutual inductance directly and shifts the resonance frequency. We calculated a mutual inductance between two pancake coils by Neumann's formula (10). Fig. 7 shows the coils structure for the following formula,

$$M = \sum_{i1} \sum_{2j} \frac{\mu_0}{4\pi} \oint_{coil1} \oint_{coil2} \frac{\cos \theta ds_1 ds_2}{r} \quad (10)$$

It is assumed that the Ritz wire is a line and a pancake coil has the structure of ring coils as shown in Fig. 5.

Fig. 8(a) shows the calculated values of mutual inductance and coupling coefficient by the change of the distance d . When the distance changes by ± 30 mm shift centering on $d = 280$ mm, the mutual inductance increases at +27% and decreases at -20% respectively. On the other hand, the resonance frequencies f_i are changed from -0.9(-0.8) to +0.7 kHz (+0.6%) when the self-inductance of the coil is $L = 6.02 \mu\text{H}$ (calculation values).

3.2 Position and inclination of pancake coils

We consider the position and inclination of pancake coils as the fluctuation of position. The mutual inductance on these cases can be calculated by Neumann's formula. Fig. 9 shows the change of mutual inductance vs. horizontal shift. The change of mutual inductance is less than about 12% when the horizontal shift of pancake coil is up to 60 mm. The fluctuation of the resonance frequency f_i is up to 0.25%.

When a pancake coil inclines by ± 10 degree, the change of mutual inductance is less than 1.9% as shown in Fig. 10. The fluctuation of the resonance frequency f_i is up to 0.1%.

3.3 Change of resonance capacitor by temperature

The applicator with wireless transmission system has the main phenomena as resonance at both exciting and inducing sides. The capacitor as one of resonance circuit changes with the operating temperature. We

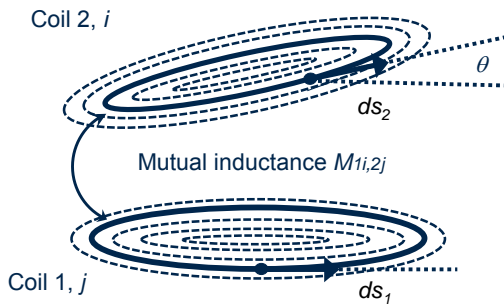
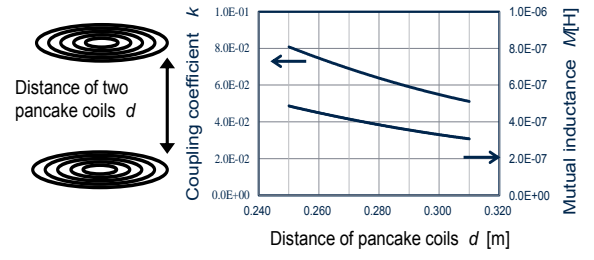
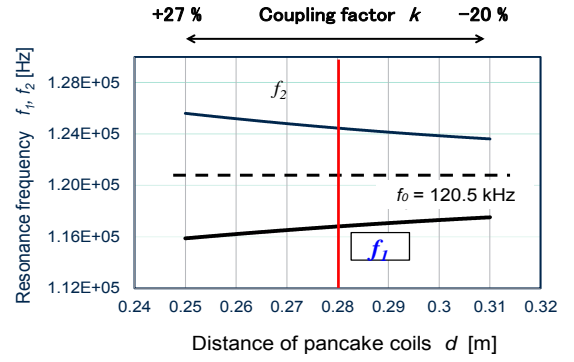

Fig. 7 Mutual inductance calculated by Neumann's formula.



(a) Mutual inductance M and coupling coefficient k vs. distance d



(b) Resonance frequencies f_1 and f_2 vs. distance d

Fig. 8 Fluctuation of resonance frequency depending on the distance of pancake coils.

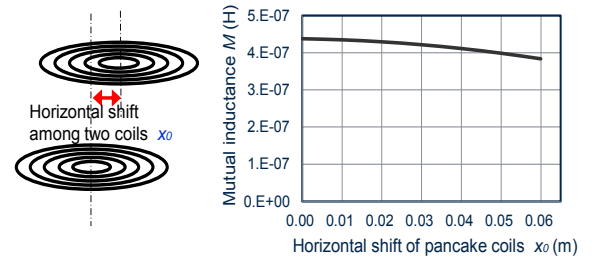

Fig. 9 Change of mutual inductance on horizontal shift of pancake coils.

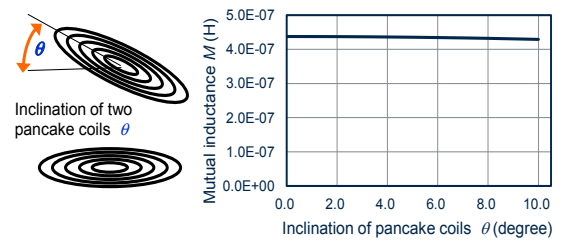

Fig. 10 Change of mutual inductance on inclination of pancake coils.

used the power capacitor made of polypropylene film (PP). Table 3 shows the properties of polypropylene material⁸⁾. We assume that the change of capacitor is up to 1.6% decrease from 20 to 100 °C. According to Eq. (5), the fluctuation of resonance frequency is up to 0.93 kHz(0.80%).

Table 3 Fluctuation of capacitor vs. temperature.

Material	Polypropylene (PP)
Thickness(mm)	3.0 - 25
Max, Op. Temp. (° C)	80-105
Temp. Char.(ppm/° C)	-400 (-100~-500)
Resistance (Ω m)	$>10^{15}$

4. Conclusion

We summarize the conclusions below,

- (1) The applicator system with wireless transmission system enables us to excite double pancake coils and to obtain the magnetic fields generated by the excitation of both pancake coils.
- (2) The fluctuation of the position movement of two coils and the resonance capacitor by temperature shifts the resonance frequency. Under a practical situation, the fluctuation of resonance frequency f_i is estimated to be less than 1 %.
- (3) The frequency of exciting power source should be tuned to the resonance frequency f_i inside the estimated fluctuation of frequency.

Acknowledgements A part of the research is in part by the Ministry of Education, Culture, Sports, Science and Technology in Japan, Grants-in-Aid for No. 24918005.

References

- 1) Y.Yamazaki I.Nagano, S.Yagitani, T.Maeda, K.Igarashi, K.Terai, H.Nagae, and K. Tazawa: *JSAEM Studies in Applied Electromagnetics and Mechanics*, **14**, 241 (2003).
- 2) I. Tohnai, Y. Goto, Y. Hayashi, M. Ueda, T. Kobayashi, and M. Matsui: *Int. J. Hyperthermia*, **12**, 37 (1996).
- 3) R. Zuchini, *et. al.* : *The Journal of Cancer Surgery*, **37**, 604 (2011).
- 4) T.Maruyama, T.Takura, F.Sato, H.Matsuki, S.Aiba, and T.Sato: *J. Magn. Soc. Jpn.*, **31**, 380 (2007).
- 5) A.Kurs, A.Karalis, R.Moffatt, J. D.Joannopoulos, P. Fisher, and M.Soljačić: *Science*, **317**, 5834, 83 (2007).
- 6) Sasada: *Digests of Magn. Soc. Jpn.*, 29aC-1, 242 (2011).
- 7) Research Institute of Human Engineering for Quality Life: <http://www.hql.jp/project/size1992/>.
- 8) Matsuo Electric Co. Ltd. : <http://www.ncc-matsuo.co.jp/pdf/filmg.pdf>.

Received October 30, 2012; Revised January 17, 2013

Accepted February 06, 2013