

Control of Exciting Frequency to Pancake Type Applicator Having Wireless Transmission for Hyperthermia Therapy

著者	Yamada Sotoshi, Ikehata Yoshio, Ueno Toshiyuki, Kakikawa Makiko
journal or publication title	Journal of the Magnetics Society of Japan
volume	38
number	2-1
page range	37-41
year	2014-01-01
URL	http://hdl.handle.net/2297/36999

doi: 10.3379/msjmag.1402R004

Control of Exciting Frequency to Pancake Type Applicator Having Wireless Transmission for Hyperthermia Therapy

S. Yamada, Y. Ikehata, T. Ueno*, and M. Kakikawa

Institute of Nature and Environmental Technology, Kanazawa Univ., *Kakuma-machi, Kanazawa 920-1192, Japan*

*Graduate School of Nature and Technology, Kanazawa Univ., *Kakuma-machi, Kanazawa 920-1192, Japan*

The hyperthermia as one of low-invasive therapies was taken notice of in aging society. There is a magnetic generating coil system, an applicator, as one research issue of the engineering developments in the medical treatment system. The proposed applicator system with the wireless transmission can be set a patient to operating bed easily and the gap between two flat coils can be adjusted to the breast thickness of a patient. But on the other hand, the distance between coils changes a mutual inductance and influences the characteristics of circuit and magnetic fields. This paper estimates the characteristics on the variation range of electric parameters by change of the size of exciting coils, and proposes the control methodology of the parameter fluctuation by a control of exciting frequency. The feasibility and performances of the apparatus were discussed by the simulation and the experiment.

Key words: hyperthermia, pancake coil, wireless transmission, resonance frequency, fluctuation, control.

1. Introduction

One of the hyperthermia therapies is high-frequency induction heating type by using nano-magnetic materials and magnetic implants¹⁾. A tumor with injected magnetic materials is heated by hysteresis and eddy-current losses under external high frequency magnetic fields with more than 200 kHz×mT²⁾. There are two types of exciting coils, solenoidal coil and flat coil to generate magnetic fields for the purpose. To generate magnetic fields at the deep position of a body and to adjust a body size of a patient, we proposed the double pancake type exciting system with two flat coils sandwiching body³⁾.

The alignment of exciting coils does not restrict flexibility of a flat coil for positioning and body size of a patient and also improves the attenuation of magnetic fields at the deep position from body surface. But two pancake coils installed separately should be series-connected in the situation where huge current flows. There are some problems in an electric wiring and piping for cooling. The wireless power transmission system could recover the drawback of the coil system.

Since the system is composed of two tuned resonant circuits with the same resonance frequency, the amplitudes of exciting and induced currents are sensitive to the change of parameters and decrease remarkably. Then we need the estimation of the change of electric parameters and the mean for recovering the performance. The paper discusses the control technique of adjusting exciting frequency to resonance frequency.

2. Pancake Coil Type Applicator and Control of Exciting Frequency

2.1 Configuration of applicator and characteristics

An applicator is installed outside of a body to heat magnetic implants and magnetic particles based on

eddy-current and hysteresis losses¹⁾. We proposed the double pancake exciting system with two flat spiral coils as shown in Fig. 1³⁾. Two coils sandwich a body and generate magnetic fields on both upper and lower. The configuration of the coils causes the increase of magnetic fields and the distribution becomes smooth near the center of two coils. It means that cancer in the deep position of body is exposed under the high and uniform magnetic fields. The distance of pancake coils is variable and made into 280 mm usually in Fig. 1. The distance fills the thickness of Japanese's breast up to 95 %⁴⁾.

On the other hand, both coils are series-connected to apply current with the same frequency, amplitude, and phase, and the exciting power source needs apparent power up to 2 times as much as a single coil. Furthermore, there brings a problem to wiring, cooling mechanism and the installation of patient at an operation in the composition of exciting coils.

We proposed the double pancake type coils with a wireless transmission system³⁾. Fig. 2 shows the outline of applicator. The lower coil with series capacitor is connected to a high frequency power source directly and the upper induced coil is connected to a resonance capacitor only. It assumes installing the coil, capacitor,

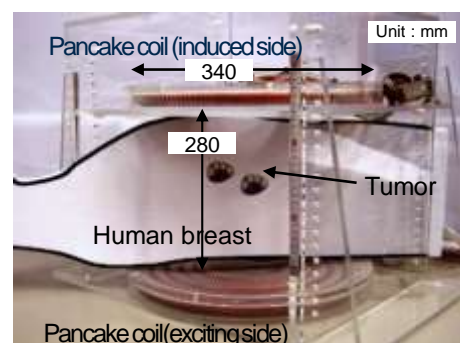

Fig. 1 Induction heating type hyperthermia with double pancake type coils.

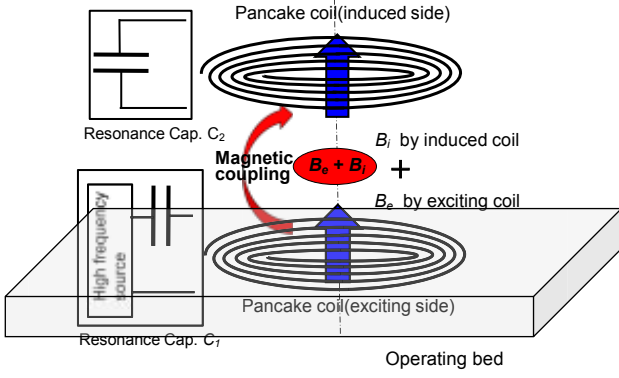

Fig. 2 Applicator with wireless transmission system.

and electric source in an operating bed. Both coils are connected by the magnetic coupling⁵⁾. The upper coil has the 3-dimensional freedom of position.

It is easy to install a patient at an operation bed as shown in Fig. 3(a). Moreover, the system gives the flexibility to adjust the distance of pancake coils according to patient's breast in Fig. 3(b). But the coupling condition depends upon the distance between two pancake coils remarkably and affects the resonance frequency and the characteristics of wireless transmission³⁾. We need some controls to keep the resonance condition and stabilize the exciting currents and magnetic fields.

2.2 Change of coupling factor and resonance frequency

The equivalent circuit of the pancake coils with wireless transmission is drawn in Fig. 4^{3), 5)}. We neglect the displacement currents and consider only the magnetic coupling between coils because of the exciting frequency of about a hundred kHz.

According to the experiments with the parameters in Table 1, the frequency characteristics on the exciting and induced circuit are shown in Fig 5. We observed two resonance frequencies (f_1 and f_2). The resonance frequency f_0 of the L-C circuit is between these frequencies. The resonance frequencies, f_1 and f_2 , are expressed by,

$$f_1 = \frac{1}{2\pi\sqrt{C_1(L_1 + M)}}, \quad f_2 = \frac{1}{2\pi\sqrt{C_2(L_2 - M)}}. \quad (1)$$

It is remarkable that the exciting and induced currents have the same amplitude near two resonance

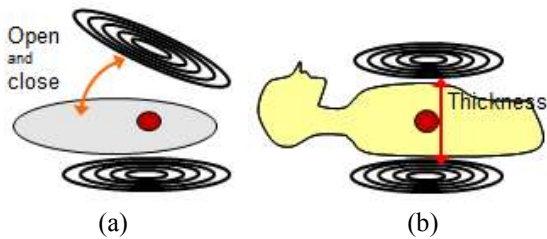

Fig. 3 Flexibility of coil distance and position for hyperthermia therapy. (a) Settlement of patient. (b) Adjustment of distance to human breast.

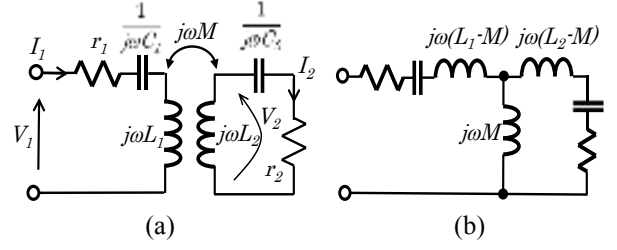

Fig. 4 Equivalent circuits of applicator with wireless transmission system. (a) Equivalent circuit. (b) T-type circuit.

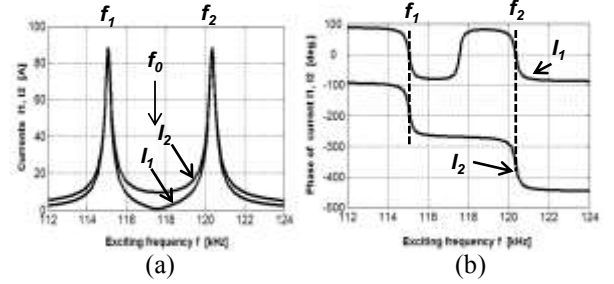

Fig. 5 Characteristics of exciting I_1 and induced currents I_2 . (a) Amplitude. (b) Phase differences to input voltage.

Table 1 Measured circuit parameters.

Parameters	Exciting coil	Induced coil
Capacitor C_1, C_2 (μF)	0.281	0.298
Inductance L_1, L_2 (μH)	6.51	6.15
Resonance freq. f_1, f_2 (kHz)	117.7	117.5
Q-value Q_1, Q_2	350	504
Resistance r_1, r_2 (m Ω)	13.6	9.15
Mutual inductance M (μH)	0.284	
Coupling factor	0.0449	

frequencies. The phase difference between the exciting and induced currents is approximately π at f_1 , and 2π at f_2 ³⁾. In order to add the magnetic fields by two coils, the exciting frequency has to be tuned to the frequency f_1 .

The distance influences a mutual inductance directly and shifts the resonance frequency. We calculated a mutual inductance M between two pancake coils by Neumann's formula (2) as,

$$M = \frac{\mu_0}{4\pi} \oint_{\text{coil1}} \oint_{\text{coil2}} \frac{\cos \theta ds_1 ds_2}{r} \quad (2)$$

The structure of a spiral coil is expressed by,

$$r(\theta) = r_0 + a(\theta/2\pi): \quad 0 < \theta < 2\pi n \quad (3)$$

where r_0 , a , and n are initial radius, pitch, and number of turns. The coil in Fig. 1 has the parameters, $r_0 = 0.0625$ m, $a = 0.025$ m, and $n = 5$. The diameter of the Litz wire is neglected as a coil with no cross-section.

Fig. 6 shows the calculated values of mutual inductance and coupling factor by the change of the distance d . When the distance changes by ± 40 mm shifting centering on $d = 280$ mm, the mutual inductance increases at +37% and decreases at -25% respectively. The resonance frequency f_1 is changed from -0.9 kHz (-0.8%) to +0.7 kHz (+0.6%) when the self-inductance of

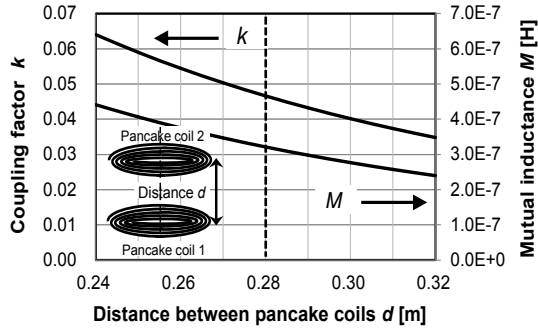

Fig. 6 Mutual inductance M and coupling coefficient k of spiral coil vs. distance d .

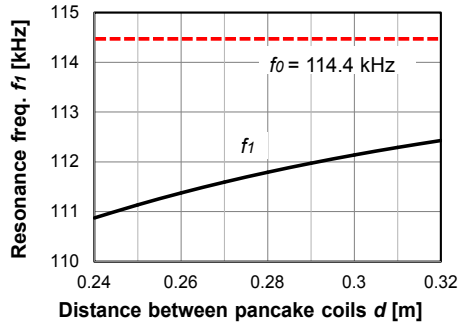

Fig. 7 Change of resonance frequency f_1 as a function of distance of coils.

the coil is $L = 6.89 \mu\text{H}$ in Table 1. The change of the resonance frequency causes the decrease of exciting currents and the phase shift from the target π . The calculation results suggests that the fluctuation of resonance frequency f_1 with 0.8 % makes exciting current as much smaller as at the resonance point as shown in Fig. 5.

2.3 Control methodology

The double pancake type exciting coils can be adjusted to a body of patient, but coupling factor and mutual inductance are changed. In order to keep the

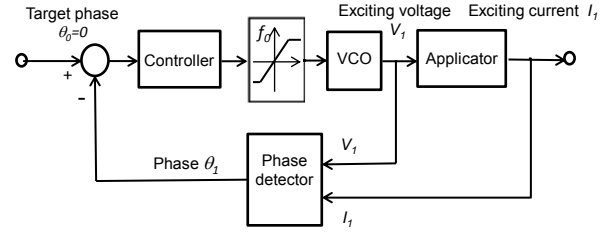

Fig. 8 Control of exciting frequency to track to resonance frequency f_1 .

resonance characteristics and the magnitude of exciting currents, the exciting frequency should track to the resonance frequency f_1 against the fluctuation of the parameters.

According to Fig. 5(a), we note that the phase of exciting current I_1 is near zero at the resonance frequency f_1 because the impedance from an input terminal becomes a resistance component at f_1 . Fig. 8 shows the fundamental control system in order to track the resonance frequency f_1 . The frequency of voltage control oscillator (VCO) is controlled to make a phase into zero. The phase characteristics have strong nonlinearity, and then it is necessary to restrict the exciting frequency so that it may not shift from the target frequency greatly. The consideration of the resonance frequency f_1 in Fig. 7 can determine the change range of VCO output.

3. Simulation and Experiment for Tracking to Resonance Frequency

3.1 Simulation of control methodology

We simulate the control system of applicator to adjust resonance frequency. Fig. 9 is the block diagram of MATLAB/Simulink program⁶⁾. The characteristics of the applicator are installed by the S-function of the analytical equation³⁾. It is because there is much difference between the response of applicator and the feedback control in time. The feedback signal of the

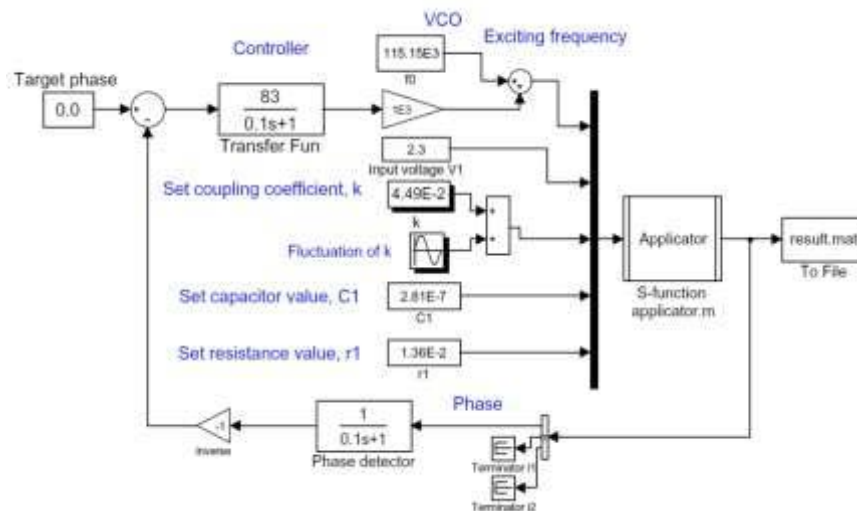

Fig. 9 Simulation program of control and applicator by MATLAB/Simulink.

phase θ_I of exciting current is controlled by PID controller.

We adopted a first-order PI controller in order to prove the stabilization of exciting current. The transient responses of phase, exciting frequency, and currents are shown in Fig. 10. The controller is,

$$G_c(s) = k_i / (Ts + 1) \quad (4)$$

where the coefficient k_i , and the time constant, are 0.1 and 83 (kHz/rad). The values are chosen as an example of the stable response. The coupling factor k is changed about 5 % with the cycle of 4 s in Fig. 10. For no control (constant frequency) in Fig. 10(a), the amplitude of exciting current varies by twice frequency of coupling factor. On the other hand, we observe that the exciting frequency is controlled against the change of a coupling factor and the current becomes constant as shown in Fig. 10(b). Fig.10(c) shows the comparison of the phase of exciting current I_I as the control variable. The result shows that the change of the phase is suppressed clearly.

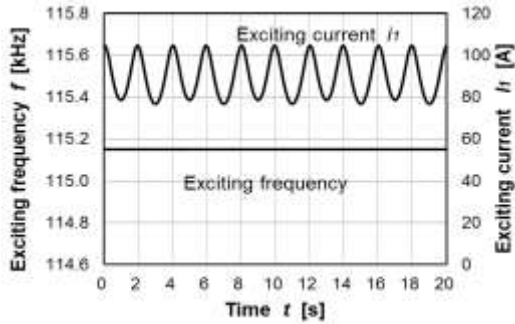

(a) Without feedback control.

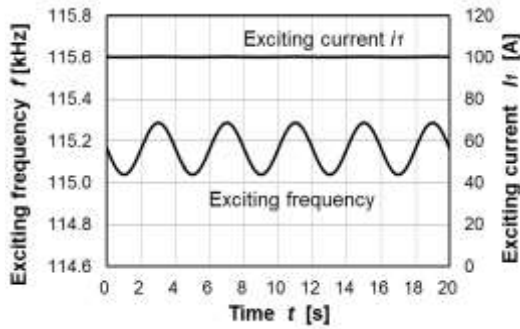

(b) With feedback control.

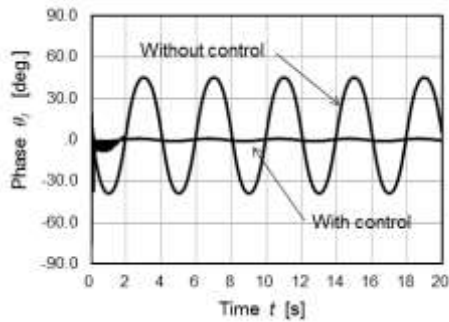

(c) Phase of exciting current, θ_I .

Fig. 10 Comparisons of exciting current between control and no control.

3.2 Experimental results

We fabricated the control system and applied it to the applicator in Fig. 1. The transfer function of controller in the experiment is the same on the simulation.

Fig. 11 shows the experimental results for the static change of the distance d between two coils. When the distance increases and the coupling factor k decreases, the exciting frequency shifts to higher as given by f_I in Eq. (1).

We changed the distance between two coils up to about 10 mm by hand periodically. Fig. 12 shows the transient response of exciting frequency against the disturbance of the distance. The current decreases with frequency tracks to the resonance point against the fluctuation of the distance by the feedback and the exciting current keeps almost constant in Fig. 12(b).

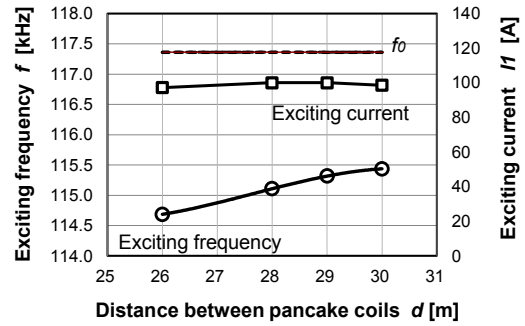
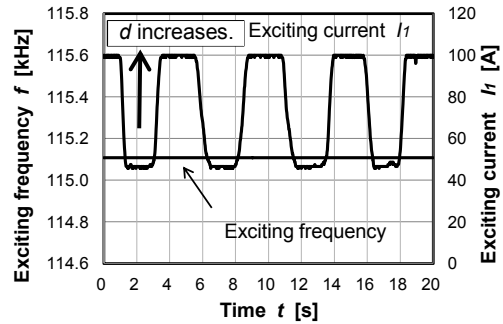
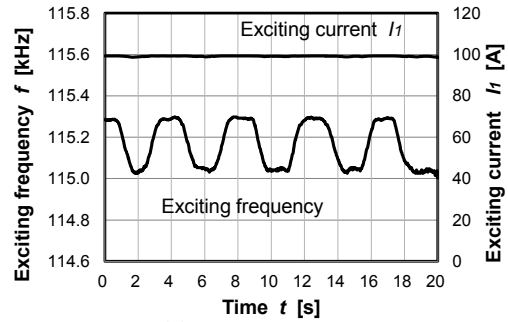

Fig. 11 Static frequency response to change of distance between pancake coils.



(a) Without control ($f = 115.1$ kHz).



(b) With control.

Fig. 12 Transient response to fluctuation of distance between pancake coils.

4. Conclusion

We summarize the conclusions below,

- (1) The applicator system with wireless transmission system enables us to excite double pancake coils.
- (2) The position movement of two coils shifts the resonance frequency. The frequency of exciting power source should be tuned to the resonance frequency f_1 .
- (3) By using the phase control feedback, it is possible to stable the exciting current and magnetic fields.

Acknowledgements A part of the research is in part by the Ministry of Education, Culture, Sports, Science and Technology in Japan, Grants-in-Aid for No. 24918005.

References

- 1) Y.Yamazaki I.Nagano, S.Yagitani, T.Maeda, K.Igarashi, K.Terai, H.Nagae, and K. Tazawa: *JSAEM Studies in Applied Electromagnetics and Mechanics*, **14**, 241 (2003).
- 2) T.Maruyama, T.Takura, F.Sato, H.Matsuki, S.Aiba, and T.Sato: *J. Magn. Soc. Jpn.*, **31**, 380 (2007).
- 3) S.Yamada, Y Ikehata, T.Ueno, and M.Kakikawa: *J. Magn. Soc. Jpn.*, **37**, 282 (2013).
- 4) Research Institute of Human Engineering for Quality Life: <http://www.hql.jp/project/size1992/>.
- 5) Sasada: *Digests of Magn. Soc. Jpn.*, 29aC-1, 242 (2011)
- 6) MATLAB/Simulink programing, T.Aoyama, (Koudansha Co. Ltd, Tokyo, 2007), chps.4 and 5 [in Japanese].

Received October 16, 2013; Revised January 19, 2014; Accepted February 4, 2014.