

Nitric oxide-cGMP signaling regulates axonal elongation during optic nerve regeneration in the goldfish in vitro and in vivo

メタデータ	言語: eng 出版者: 公開日: 2017-10-03 キーワード (Ja): キーワード (En): 作成者: メールアドレス: 所属:
URL	http://hdl.handle.net/2297/18478



Nitric oxide-cGMP signaling regulates axonal elongation during optic nerve regeneration in the goldfish in vitro and in vivo



Journal:	<i>Journal of Neurochemistry</i>
Manuscript ID:	JNC-E-2009-0240.R2
Manuscript Type:	Original Article
Date Submitted by the Author:	
Complete List of Authors:	Koriyama, Yoshiki; Kanazawa University, Department of Molecular Neurobiology Yasuda, Rie; Kanazawa University, Department of Laboratory Sciences Homma, Keiko; Kanazawa University, Department of Laboratory Sciences Mawatari, Kazuhiro; Kanazawa University, Department of Laboratory Sciences Nagashima, Mikiko; Kanazawa University, Department of Laboratory Sciences Sugitani, Kayo; Kanazawa University, Department of Laboratory Sciences Matsukawa, Toru; Kanazawa University, Department of Molecular Neurobiology Kato, Satoru; Kanazawa University, Department of Molecular Neurobiology
Keywords:	Nitric oxide, Regeneration, Fish, Optic nerve, Neural nitric oxide synthase, cGMP

1
2
3
4
5
6
7
8 Nitric oxide-cGMP signaling regulates axonal elongation
9
10 during optic nerve regeneration in the goldfish *in vitro* and *in vivo*
11
12
13
14

15 Yoshiki Koriyama*, Rie Yasuda, Keiko Homma, Kazuhiro Mawatari, Mikiko Nagashima,
16

17 Kayo Sugitani, Toru Matsukawa, and Satoru Kato
18
19
20

21
22 Department of Molecular Neurobiology and Division of Laboratory Sciences, Graduate
23 School of Medicine, Kanazawa University, 13-1 Takara-machi, Kanazawa 920-8640, Japan
24
25
26
27

28
29 Keywords: Nitric oxide, Neuronal nitric oxide synthase, cGMP, Optic nerve, Regeneration,
30
31 Fish
32
33

34 Running title: NO-cGMP promotes optic nerve regeneration in fish
35
36
37

38 Abbreviations:
39

40 CTB, subunit B of cholera toxin;
41

42 c-PTIO, 2-(4-carboxyphenyl)-4,4,5,5-tetramethylimidazoline-1-oxyl-3-oxide;
43
44

45 dbcGMP, dibutyryl cGMP;
46
47

48 ETPI, S-ethyl-N-[4-(trifluoromethyl) phenyl] isothiourea;
49

50 FBS, fetal bovine serum;
51

52 GCL, ganglion cell layer;
53

54 IBMX, 3-isobutyl-1-methyl-xanthine;
55
56

57 INL, inner nuclear layer;
58

59 L-NAME, N-nitro-L-arginine methyl ester;
60

MTT, 3-[4,5-dimethylthiazol-2-yl]-2,5-diphenyltetrazolium bromide;

1
2
3
4 NADPHd, NADPH diaphorase;

5
6 NOR2, (+/-)-(E)-4-methyl-2-[(E)-hydroxyimino]-5-nitro-3-hexenamide;

7
8 NOS, nitric oxide synthase;

9
10 ODQ, 1H-[1,2,4] oxadiazole[4,3- α]quinoxaline-1-one;

11
12 ONL, outer nuclear layer;

13
14 PDE, phosphodiesterase;

15
16 PKG, cGMP-dependent protein kinase;

17
18 RALDH2, retinaldehyde dehydrogenase 2;

19
20 RGCs, retinal ganglion cells;

21
22 Rp-cGMPS, Rp- β -Phenyl-1, N²-etheno-8-bromoguanosine 3',5'-cyclic
23
24
25
26
27
28
29
30
31
32
33
34
35
36
37
38
39
40
41
42
43
44
45
46
47
48
49
50
51
52
53
54
55
56
57
58
59
60
monophosphorothioate;

29 sGC, soluble guanylate cyclase;

30 siRNA, small interfering RNA;

31 SNAP, S-nitroso-N-acetyl-penicillamine

38 *Address for correspondence: Department of Molecular Neurobiology, Graduate School of
39
40
41
42
43
44
45
46
47
48
49
50
51
52
53
54
55
56
57
58
59
60
Medicine, Kanazawa University, Kanazawa 920-8640, Japan

45 TEL: 81 76 265 2450

46
47
48 FAX: 81 76 234 4235

49
50
51
52
53
54
55
56
57
58
59
60
E-mail: koriyama@med.kanazawa-u.ac.jp

Abstract

Nitric oxide (NO) signaling results in both neurotoxic and neuroprotective effects in CNS and PNS neurons, respectively, after nerve lesioning. We investigated the role of NO signaling on optic nerve regeneration in the goldfish (*Carassius auratus*). NADPH diaphorase staining revealed that nitric oxide synthase (NOS) activity was upregulated primarily in the retinal ganglion cells (RGCs) 5-40 days after axotomy. Levels of neuronal NOS (nNOS) mRNA and protein also increased in the RGCs alone during this period. This period (5-40 days) overlapped with the process of axonal elongation during regeneration of the goldfish optic nerve. Therefore, we evaluated the effect of NO signaling molecules upon neurite outgrowth from adult goldfish axotomized RGCs in culture. NO donors and dibutyl cGMP increased neurite outgrowth dose-dependently. In contrast, a nNOS inhibitor and siRNA, specific for the nNOS gene, suppressed neurite outgrowth from the injured RGCs. Intraocular dibutyl cGMP promoted the axonal regeneration from injured RGCs *in vivo*. None of these molecules had an effect on cell death/survival in this culture system. This is the first report showing that NO-cGMP signaling pathway through nNOS activation is involved in neuroregeneration in fish CNS neurons after nerve lesioning.

Introduction

Nitric oxide (NO) is a free radical gas that acts as an intracellular and intercellular messenger in the nervous system (Garthwaite et al. 1999). It is involved in a variety of biological phenomena, including axonal targeting, synaptogenesis, neuronal plasticity, and cell survival (Estévez et al. 1998; Posada and Clarke 1999; Cogen and Cohen-Cory, 2000). There are three classes of nitric oxide synthase (NOS) in the nervous system, the constitutive neuronal and endothelial isoforms and the inducible isoform (nNOS, eNOS and iNOS, Alderton et al. 2001). NO signaling appears to have an adverse effect upon neuronal survival after axotomy in the visual system. Normally, axotomized mammalian retinal ganglion cells (RGCs) die rapidly in large numbers (Grafstein and Ingoglia 1982; Villegas-Pérez et al. 1993). Axotomized rat RGCs increase nNOS expression and degenerate via NO-mediated excitotoxicity (Lee et al. 2003). On the other hand, in the PNS, sensory neurons of the dorsal root ganglia and motor neurons of facial and hypoglossal nuclei increase nNOS expression and can survive for a significant period (6 weeks) following nerve transection (Verge et al. 1992; Yu 1994). Such a line of evidence suggests that the response of NOS activity after axotomy is different in these nervous tissues in CNS and PNS and therefore the role of NOS induction in the nervous system after axotomy is not yet understood.

In contrast to mammals, fish RGCs can survive and regrow their axons, even after optic nerve transection (Sperry 1948; Grafstein 1975; Kato et al. 1999; Koriyama et al. 2007; Homma et al. 2007). Thus, the fish visual system is an ideal model for CNS regeneration (Kato et al. 2007). The regrowing optic axons begin to sprout 5-6 days, reinnervate the tectum within 5-6 weeks, and complete visual function is recovered within 5-6 months after axotomy (Kato et al. 2007). Our objective is to evaluate the role of NOS-NO system upon nerve regeneration, because NO appears to have a variety of interesting local actions following nerve injury. NO also activates soluble guanylate cyclase (sGC), which leads to the formation of cGMP and thus the activation of cGMP-dependent protein kinase (PKG,

1
2
3
4 Garthwait et al. 1999). We evaluated the role of NO-cGMP in goldfish RGCs following
5
6 optic nerve lesion using specific genetic and pharmacological procedures. We also
7
8 investigated the pathways for NO-cGMP signaling during nerve regeneration. Our data
9
10 show that NO-cGMP signaling, as a result of nNOS activation, plays a key role for optic
11
12 nerve regeneration in the goldfish retina.
13
14
15
16
17
18
19
20
21
22
23
24
25
26
27
28
29
30
31
32
33
34
35
36
37
38
39
40
41
42
43
44
45
46
47
48
49
50
51
52
53
54
55
56
57
58
59
60

For Peer Review

Material and methods

Animals

We used common goldfish (*Carassius auratus*, 7-8 cm body length). Goldfish was anesthetized with ice-cold water. The tissue surrounding the eye was removed to provide access to the optic nerve. We cut the optic nerve 1 mm away from the posterior of the eyeball using scissors. Following this, the fish were held at 22°C until they were euthanized for *in vitro* or *in vivo* sampling.

Chemicals

We used the following chemicals, obtained from Sigma-Aldrich: dibutyryl cGMP (dbcGMP), 3-isobutyl-1-methyl-xanthine (IBMX), N-nitro-L-arginine methyl ester (L-NAME), 1H-[1,2,4]oxadiazole[4,3- α]quinoxaline-1-one (ODQ), Rp- β -Phenyl-1,N²-etheno-8-bromoguanosine 3',5'-cyclic monophosphorothioate (Rp-cGMPS), S-nitroso-N-acetyl-penicillamine (SNAP). The nNOS inhibitor, S-ethyl-N-[4-(trifluoromethyl) phenyl] isothiourea (ETPI), was purchased from Alexis Co. (San Diego, CA, USA), and (+/-)-(E)-4-methyl-2-[(E)-hydroxyimino]-5-nitro-3-hexenamide (NOR2) was purchased from Dojin Chemical Co., Ltd. (Kumamoto, Japan). 2-(4-carboxyphenyl)-4,4,5,5-tetramethylimidazoline-1-oxyl-3-oxide (c-PTIO) was gently a gift from Dr. K. Chiba and Dr. M. Yamazaki.

NADPH diaphorase staining

NADPH diaphorase (NADPHd) staining was performed following the method of Williams et al. (1994). Tissue fixation and cryosection were performed as described previously (Barthel and Raymond 1993). Briefly, the eyes were enucleated and fixed in 4% paraformaldehyde solution containing 0.1 M phosphate buffer (pH 7.4) and 5% sucrose for 2 h at 4°C. The sucrose concentration was gradually increased from 5 to 20%. The eyes were then embedded

1
2
3
4 in optimal cutting temperature (OCT®) compound (Tissue Tek; Miles, Eikhart, IN) and
5
6 cryosectioned at 12 µm thickness. The frozen sections were mounted onto silane-coated glass
7
8 slides and air-dried. The slides were then brought to room temperature and incubated
9
10 overnight in 0.1 M Tris-HCl (pH 8.0) containing 0.3% Triton-X 100. Each sample was stained
11
12 in buffer containing NADPH and 4-nitroblue tetrazolium chloride (Roche) for 2-3 h at 37°C.
13
14
15
16
17

18 **Measurement of nitrite production**

19
20 We measured the concentration of nitrite in the retina using Griess method (as an indicator of
21
22 NO production) (Green et al. 1982). After homogenization with hypotonic (10 times diluted)
23
24 PBS including 1 mM EGTA and centrifugation (12,000 x g, 10 min), the retinal supernatant
25
26 was mixed with Griess reagent (1% sulfanilamide solution and 0.1%
27
28 N-(1-naphthyl)-ethylenediamine dihydrochloride) and allowed to sit at room temperature for
29
30 10 min. We then measured the absorbance at 550 nm using a microplate reader (Model 680,
31
32 Bio Rad). We used sodium nitrite to construct a standard curve.
33
34
35
36
37

38 **goldfish nNOS cDNA cloning**

39
40 Forward and reverse primers for goldfish nNOS cDNA were constructed based on zebrafish
41
42 cDNA sequences (data base No. AY211528, Gen Bank). We sequenced the resulting cDNA
43
44 fragment and compared it to the zebrafish nNOS cDNA sequence using the FASTA program.
45
46
47
48
49

50 ***In situ* hybridization**

51
52 At various times after optic nerve transection, we performed *in situ* hybridization on the
53
54 goldfish retina using digoxigenin-labeled RNA probes (Roche Diagnostics FmbH, Germany),
55
56 following the method of Komminoth (1992). nNOS cRNA probes from the 490 bp nNOS
57
58 cDNA fragment were generated with SP6 and T7 RNA polymerases (Roche Diagnostics
59
60 FmbH, Germany).

Immunohistochemistry

We studied the expression of nNOS protein in the goldfish retina using immunohistochemistry. The retinal tissues were fixed and cryosectioned as described above. After washing and blocking with Blocking One (Nacalai Tesque, Kyoto, Japan), the retinal sections were incubated with the primary anti-nNOS antibody (Sigma, 1:100) at 4°C overnight. The sections were then incubated with anti-IgG (Santa Cruz, 1:200) for 1 h at room temperature. The signal was detected using horseradish peroxidase-conjugated streptavidin and 3-amino-9-ethylcarbazole (Dako, Denmark). In the GAP-43 immunohistochemical study, retinal explants were fixed by 0.1% glutaraldehyde (Wako, Osaka, Japan) for 30 min at room temperature. Neurites from retinal explants were stained using anti-GAP-43 antibody (Santa Cruz, 1:500).

Western blotting analysis

The retinas were immersed in Tris-HCl buffer (pH 7.4) containing a protease inhibitor cocktail (Sigma-Aldrich), and were then sonicated and centrifuged as described previously (Koriyama et al. 2008). Following SDS-PAGE, the proteins were transferred onto a nitrocellulose membrane (Amersham International, U.K.). The membrane was incubated in a blocking buffer for 1 h at room temperature, then probed with primary anti-nNOS antibody (Sigma-Aldrich, 1:100) in blocking buffer at 4°C overnight. Western blot analysis of β -actin was also performed with anti- β -actin antibody (GeneTex, Inc., San Antonio, TX, 1:250). As the following this, the membrane was washed, probed with a secondary anti-IgG antibody (Santa Cruz, 1:100) in blocking buffer for 1 h at room temperature, then re-washed. The signal (160 kDa of nNOS protein) was detected using 3,3'-diaminobenzidine tetrahydrochloride. The proteins on the acrylamide gel were stained using a rapid stain Coomassie Brilliant Blue kit (Nacalai Tesque, Kyoto). The nNOS protein band was densitometrically analyzed using Scion Image software (Scion Corp., Frederick, MD). All

1
2
3
4 experiments were repeated at least 3 times.
5
6
7

8 **Retinal explant culture**

9
10 The retinal explant culture was performed as described previously (Matsukawa et al. 2004).
11 Briefly, the goldfish retinas were isolated under sterile conditions 5 days after optic nerve
12 injury. Retinal explants were cultured at 28°C in L-15 medium containing 10% fetal bovine
13 serum (FBS) in a poly-D-lysine coated, 35 mm dish. Inhibitors and NO donors were added to
14 the culture medium. After 5 days we observed neurite outgrowth using phase contrast
15 microscopy. Positive neurite outgrowth was defined on the basis of the length (>150 µm) and
16 density (more than 5 neurites per explant) of the neurites, following the description in our
17 previous study (Sugitani 2006). The percentage of explants with long neurites was compared
18 with the control culture (no treatment).
19
20
21
22
23
24
25
26
27
28
29
30
31
32
33

34 **RNA interference (RNAi)**

35 We used small interfering RNA (siRNA) for the target region to goldfish nNOS mRNA,
36 5'-GACAGCUCUCGAUACAACA-3' (Sigma Aldrich Japan) and randomly shuffled
37 sequence (5'-GAGCCAAUACCCGAUAAUC-3'). Transfection of siRNA into the retinal
38 explants was carried out using Lipofectamine 2000 (Invitrogen). To suppress the nNOS
39 expression in transcription levels, the goldfish optic nerve was cut 2 days before eye
40 nucleation. Goldfish retinas were isolated and sectioned in to 0.5 mm squares, and
41 resuspended in L-15 medium without serum or antibiotics. For each transfection sample, 2 µl
42 Lipofectamine 2000 diluted in 98 µl L-15 medium, was mixed with 100 pmol siRNA, diluted
43 in 100 µl of L-15 medium, then incubated for 20 min at room temperature to allow complex
44 formation. The mixture was then added to 0.8 ml of the resuspended retinal culture. Retinal
45 explants were gently mixed in the culture media for 3 h, then divided into two 35 mm culture
46 dishes and incubated overnight at 28°C. Following this, we added FBS to each dish and
47
48
49
50
51
52
53
54
55
56
57
58
59
60

1
2
3
4 cultured.

5 6 **MTT assay**

7
8 To determine the cell viability in the retinal explants treated with various kinds of reagents,
9 we performed 3-[4,5-dimethylthiazol-2-yl]-2,5-diphenyltetrazolium bromide (MTT) assay.
10 Briefly, 40 μ l of solution of 2.75 mg/ml MTT (Dojin, Japan) in PBS was added to each 400 μ l
11 medium as described previously (Koriyama et al. 2003). The plates were incubated at 37 °C
12 for 6 h before HCl/isopropanol was added into the medium to solubilize the reaction product
13 formazan. Absorption at 550 nm of each sample was measured with a microplate reader. Data
14 were expressed relative to the control.
15
16
17
18
19
20
21
22
23
24
25
26

27 **Anterograde labeling of regenerating optic axons with cholera toxin B**

28
29 The goldfish had optic nerve crush and were divided to two groups, in which one was injected
30 with intraocular 2 μ l of dbcGMP (20 mM in PBS) and the other was injected with PBS alone
31 at the day of nerve crush (0 day). The both groups of goldfish were intraocularly labeled with
32 5 μ l of cholera toxin B (2.5 μ g/ μ l in PBS, CTB, Sigma-Aldrich) at 8 days after nerve crush.
33 Then, the optic nerves of both groups were isolated, fixed and cryosectioned longitudinally in
34 16 μ m thickness at 10 days after nerve injury. The sections were incubated with primary
35 anti-CTB antibody (Acris, Antibodies, Hiddenhausen, Germany, 1:100). The signal was
36 detected using Alexa Fluor IgG (Molecular Probes).
37
38
39
40
41
42
43
44
45
46
47
48
49
50
51

52 **Retrograde labeling of regenerating RGCs**

53
54 The regenerating RGCs were retrogradely labeled using 1 μ l of 2% FluoroGold (Biotium,
55 Hayward, CA). The label was administered to three groups of goldfish: 1) control goldfish, 2)
56 goldfish with crushed nerves and an intraocular injection of 2 μ l of PBS, and 3) goldfish with
57 crushed nerves and an intraocular injection of 2 μ l of 20 mM dbcGMP, by slowly injecting
58
59
60

1
2
3
4 into the central part of the tectum. Both optic nerves were crushed using forceps, as
5
6 previously described (Koriyama et al. 2007). The number of regenerating RGCs was
7
8 calculated by counting the positive cells in the central part of the whole-mounted retina,
9
10 which had been treated with FluoroGold 5 days before sacrifice, 3 weeks after nerve injury.
11
12 We counted the number of positive RGCs at 25 visual fields per retina using a microscopic
13
14 and ImageJ analyzing software.
15
16
17
18
19

20 **Statistics**

21
22 We report the mean \pm S.E.M. for 3-5 experiments. Differences between groups were analyzed
23
24 using ANOVA followed with Dunnett's multicomparison test. P values < 0.05 were
25
26 considered to be statistically significant.
27
28
29
30
31
32
33
34
35
36
37
38
39
40
41
42
43
44
45
46
47
48
49
50
51
52
53
54
55
56
57
58
59
60

Results

< ----- Fig. 1

Increase in NOS activity in goldfish RGCs following nerve injury

NOS activity is associated with NADPH diaphorase (NADPHd) activity (Dawson et al. 1991). Thus we measured the changes in NADPHd using histochemistry after nerve lesioning. The distribution of NADPHd positive cells in the control retina was similar to previous observations in fish (Weiler and Kewitz 1993; Liepe et al. 1994; Devadas et al. 2001). We observed intense staining in the photoreceptor cells and horizontal cells. Conversely, the staining was much weaker in the inner nuclear layer (INL) and the ganglion cell layer (GCL) (Fig. 1A). The number of NADPHd positive cells increased significantly in the GCL 5 days after axotomy, and peaked 20 days (Fig. 1B) after axotomy. NADPHd staining returned to control levels by day 40 (Fig. 1C). We did not observe any change in the NADPHd signal in other neuronal components during this period.

The amount of nitrite produced in the retina increased within 5 days after lesioning, peaked at day 20, and decreased gradually thereafter (Fig. 1D). The concentration of nitrite was reduced by 23.5% of control in the presence of intraocular L-NAME, a NOS inhibitor (data not shown).

< ----- Fig. 2

Distribution of nNOS mRNA in the goldfish retina during optic nerve regeneration

To evaluate changes in nNOS mRNA expression during optic nerve regeneration, we constructed primers for goldfish nNOS cDNA using the zebrafish cDNA sequence (Gen Bank No. AY 211528). We obtained a single band consisting of a 490 bp goldfish cDNA fragment using RT-PCR. The cDNA fragment isolated from goldfish retinal RNA exhibited a high degree of homology (90.8%) with the zebrafish oxygenase domain sequence (1427 -1916 bp) for nNOS cDNA (data not shown), suggesting that the fragment was goldfish nNOS cDNA. Using the nNOS cRNA probe, we studied the change in nNOS mRNA in the goldfish retina after optic nerve injury with *in situ* hybridization. The pattern of nNOS mRNA expression in

1
2
3
4 the control retina was similar to that observed in NADPHd staining. The signal was strongest
5
6 in the photoreceptors and weaker in the INL and the GCL (Fig. 2A). The levels increased
7
8 significantly only in the GCL, 20 days after axotomy (Fig. 2B). Levels decreased gradually
9
10 thereafter and were similar to the control retina 40 days after nerve lesioning (Fig. 2C).

11
12
13 < ----- Fig. 3

14 15 *Upregulation of nNOS protein in the goldfish retina after axotomy*

16
17 We also measured levels of nNOS protein in the goldfish retina after optic nerve injury using
18
19 Western blotting analysis. The levels of nNOS protein increased at 5 days, peaked at 20 days,
20
21 and returned to the control level 40 days after axotomy (Fig. 3A). Levels of β -actin were
22
23 unchanged during this period. To determine where the upregulation of nNOS protein was
24
25 localized, we performed immunohistochemistry. We observed strong immunoreactivity in the
26
27 photoreceptor cells and INL, and weak immunoreactivity in the GCL of the control retina (Fig.
28
29 3B). nNOS immunoreactivity significantly increased only in the GCL at 5 days and peaked
30
31 at 20 days after nerve lesioning. Conversely, there was no change in immunoreactivity in the
32
33 other neurons (Fig. 3C). The increase in nNOS reactivity in the GCL was localized to the
34
35 RGCs by simultaneous staining of TUJ1, a specific ganglion cell marker (data not shown).
36
37 The level of immunoreactivity in the RGCs decreased to that of the control retina 40 days
38
39 after axotomy (Fig. 3D).

40
41
42
43
44
45
46 < ----- Fig. 4

47 48 *Neurite outgrowth from adult goldfish retina controlled by NO generation*

49
50 We tested the effect of NO generator or NOS inhibitor upon neurite outgrowth in retinal
51
52 explant culture. The percentage of retinal explants with outgrowing neurites was compared to
53
54 that of the control retinal explant, in which the optic nerve had 5 days post conditioning lesion
55
56 (Landreth and Agranoff 1976). Spontaneous neurite outgrowth in the primed control retina
57
58 during 5 days of culture was designated as 100% (Fig. 4A and B, control). We observed a
59
60 significant number of explants with long neurites in the control culture (Fig. 4C). NOR2, a

1
2
3
4 NO generator at doses of 50-100 μ M increased neurite outgrowth 150% of the control.
5
6 However, we saw no effect at doses less than 50 μ M of NOR2 (Fig.4A). In the presence of
7
8 100 μ M of NOR2, a large number of explants with long neurites (> 200 μ m in length) could
9
10 be seen (Fig. 4D). SNAP, an another NO generator at 500 μ M also induced long neurite
11
12 outgrowth (Fig.4E). The majority of neurites induced from explants was positively stained
13
14 with anti-GAP43 immunohistochemistry (Fig. 4F). In contrast, neurite outgrowth was
15
16 dose-dependently inhibited by L-NAME, a universal NOS inhibitor (Fig. 4B). Neurite
17
18 outgrowth was significantly inhibited (40-60%) at doses of 200-400 μ M L-NAME relative to
19
20 the control (Fig. 4B and G). Next, we tested the effect of combined L-NAME plus NOR2 on
21
22 neurite outgrowth. NOR2 (50-100 μ M) significantly reversed the inhibition of neurite
23
24 outgrowth by 400 μ M L-NAME (Fig. 4B). The combination of L-NAME plus NOR2 restored
25
26 levels to 80-90% of the control (Fig. 4H, L-NAME plus NOR2).
27
28
29
30

31 < ----- Fig. 5

32
33
34 *Timing of NO stimulation on neurite outgrowth from adult goldfish retina.*

35
36 We tested the effect of c-PTIO, a NO specific scavenger on neurite outgrowth in culture.
37
38 Carboxy-PTIO (100 μ M) significantly suppressed the neurite outgrowth (40% of control, Fig.
39
40 5A and 5C) as compared to the control (Fig. 5A and 5B). Therefore, we used this c-PTIO to
41
42 determine the action time of NO with a NO generator, NOR2. Carboxy-PTIO was added to
43
44 the culture medium at different time points after NOR2 stimulation. Carboxy-PTIO (100 μ M)
45
46 application blocked the neurite outgrowth at the same time (0 h) after NOR2 (100 μ M)
47
48 treatment (Fig. 5A). Carboxy-PTIO application at 3 h after NOR2 treatment moderately
49
50 blocked the neurite outgrowth (Fig. 5A and 5D) but its application at 6 h after NOR2
51
52 treatment did not block the neurite outgrowth like NOR2 alone (Fig. 5A and 5E).
53
54
55
56
57
58
59
60

< ----- Fig. 6

1
2
3
4 *Neurite outgrowth from adult goldfish retina controlled by nNOS-NO system*

5
6 To determine the effect of nNOS on neurite outgrowth, we used nNOS specific genetic and
7
8 pharmacological approaches. First, the nNOS specific inhibitor ETPI (10, 20, 40 μ M)
9
10 suppressed neurite outgrowth by 40-60% relative to the control (Fig. 6A). The effective dose
11
12 of ETPI (10-40 μ M) was one order of magnitude lower than that of the nonspecific inhibitor,
13
14 L-NAME (400 μ M) (cf. Fig. 4B). We did not observe any significant neurite outgrowth in this
15
16 culture (Fig. 6B). We then tested the effect of nNOS cDNA specific RNAi. The levels of
17
18 nNOS protein were decreased by 60% following nNOS specific RNAi treatment, relative to
19
20 the control (Fig. 6C). Conversely, the levels of nNOS protein did not change in cultures of
21
22 RNAi for scramble sequences (Fig. 6C). The nNOS specific RNAi treatment significantly
23
24 inhibited neurite outgrowth by 45% relative to the control or scrambled treatment (Fig. 6D).
25
26 We observed only short neurites following treatment with nNOS specific RNAi (Fig. 6F)
27
28 which was in contrast to the longer neurites in the scrambled treatment (Fig. 6E). Taken
29
30 together, these data suggest that nNOS preferentially generates NO to promote neurite
31
32 outgrowth in the goldfish retina after axotomy.
33
34
35
36
37

38 < ----- Fig. 7

39
40
41 *Neurite outgrowth from the adult goldfish retina is controlled by cGMP*

42
43 We investigated the involvement of cGMP upon neurite outgrowth to elucidate the pathway
44
45 for the nNOS-NO signaling cascade. A single treatment of IBMX (500 μ M), a nonspecific
46
47 inhibitor of cyclic nucleotide phosphodiesterase (PDE), which increase intracellular cyclic
48
49 nucleotide had no effect on neurite outgrowth relative to the control (Fig. 7A). In contrast,
50
51 SNAP, an NO donor (500 μ M), significantly increased neurite outgrowth (Fig. 7A, cf. Fig.
52
53 4E). There was no difference in neurite outgrowth between the explants treated with SNAP
54
55 alone or a combination of IBMX and SNAP (Fig. 7A). Next, we investigated the effect of
56
57 dbcGMP, a membrane permeable cGMP analog, on neurite outgrowth in the adult goldfish
58
59 retina. Dibutyl cGMP increased neurite outgrowth dose-dependently (Fig. 7B). We observed
60

1
2
3
4 a large number of explants with long neurites following treatment with 400 μ M dbcGMP (Fig.
5
6 7E) relative to the control (Fig. 7D). We saw no effect at the lowest dose of dbcGMP (100
7
8 μ M) (Fig. 7B).

10
11 To determine which NO or cGMP induces neurite outgrowth, we tested the effect of
12
13 ODQ, a selective sGC inhibitor, on neurite outgrowth. ODQ (100 μ M) clearly inhibited
14
15 neurite outgrowth by 30% relative to the control (Fig. 7C). We did not observe any significant
16
17 neurite outgrowth by ODQ in this culture (Fig. 7F). Interestingly, the combination of 100 μ M
18
19 ODQ and 200-400 μ M dbcGMP reversed the effect of ODQ alone (Fig. 7C). We observed a
20
21 large number of explants with long neurites in this culture of dbcGMP and ODQ (Fig. 7G).

24
25 Last, we tested the effect of Rp-cGMPS, a specific inhibitor of PKG on neurite
26
27 outgrowth from goldfish retina. Rp-cGMPS dose-dependently inhibited the neurite outgrowth
28
29 (Fig. 7H). Only a small number of explants with short neurites were observed in this culture
30
31 (10 μ M Rp-cGMPS) (Fig. 7I). Furthermore, the combination of 500 μ M SNAP and 10 μ M
32
33 Rp-cGMPS did not restore neurite outgrowth (Fig. 7H).

36 < ----- Fig. 8

38 *Cell viability in the retinal explants.*

40
41 To determine, whether or not the NO-cGMP related agents affect to cell viability, we
42
43 quantified cell survival by MTT assay after treatment. Fig. 8 shows that NO generators, all
44
45 inhibitors, NO scavenger and dbcGMP have not any effect on cell viability relative to the
46
47 control.

50 < ----- Fig. 9

52 *CyclicGMP promotes optic nerve regeneration in vivo.*

54
55 As dbcGMP actually induced neurite outgrowth from adult goldfish retina in culture, we
56
57 studied effect of dbcGMP on optic nerve regeneration *in vivo*. We measured number of
58
59 regenerating fibres in the optic nerve and reinnervating RGCs to the tectum by using
60
anterograde and retrograde labeling methods. Intraocular injection of CTB revealed that a

1
2
3
4 large number of nerve fibres in goldfish treated with dbcGMP were proceeding over the crush
5
6 site (marked with an asterisk) at 10 days after nerve injury (Fig. 9B) as compared to those in
7
8 goldfish treated with PBS alone (Fig. 9A). Tectal injection of FluoroGold revealed that a large
9
10 number of retinal ganglion cells were retrogradely labeled in the intact fish (Fig. 9C). The
11
12 quantitative data for the labeled RGCs are shown in Fig. 9F. In the goldfish with intraocular
13
14 injection of 2 μ l of PBS, the number of labeled RGCs was only 40% of the intact retina (Figs.
15
16 9D and 9F). In the goldfish with intraocular injection of 2 μ l of 20 mM dbcGMP (intraocular
17
18 concentration \sim 400 μ M), the number of labeled RGCs was increased 70% of the intact retina
19
20 3 weeks after nerve crush (Figs. 9E and F). Together, our results suggest that dbcGMP
21
22 promotes goldfish optic nerve regeneration *in vivo*.
23
24
25
26
27
28
29
30
31
32
33
34
35
36
37
38
39
40
41
42
43
44
45
46
47
48
49
50
51
52
53
54
55
56
57
58
59
60

Discussion

nNOS activation in the goldfish RGCs after optic nerve injury.

In the control goldfish retina, the expression of nNOS mRNA and protein could be seen positively in all nuclear layers (outer, inner nuclear and ganglion cell layers). Following the optic nerve transection, the nNOS expression increased primarily in the ganglion cell layer at 5 days, peaked at 20 days and then returned to the control level by 40 days after axotomy (Fig. 2 and 3). The positive cells in the ganglion cell layer were confirmed as RGCs by TUJ1 immunohistochemistry. NOS activity in NADPHd and NO production in nitrite product further supported this result. The goldfish RGCs can regrow their axons and reinnervate the tectum within this period of 5-40 days after injury (Kato et al. 2007). In rat retina, Lee et al. (2003) reported that nNOS protein levels increased 2.5 fold in the RGCs at 5-7 days, and then decreased 1.3 fold at 28 days after injury. Almost 90% of rat RGCs rapidly died within this period of 7-28 days after axotomy. Accompanying to the nNOS activation in the RGCs after axotomy, there is high expression of iNOS in the Müller cells in rat (Koeberle and Ball 1999). The iNOS activation in the glial Müller cells after optic nerve injury is limited to the mammalian retina (Koistinaho and Sagar 1995). In our goldfish data, there is no increase of NADPHd staining in the Müller cells after axotomy (Fig. 1). The over production of NO in both the RGCs and the Müller glia in rat might result in the apoptosis of RGCs (Neufeld et al. 1999), although the sensitivity of NO on the survival or cell death is different (Goureau et al. 1999, Kawasaki et al. 2000). Depending on intracellular concentration of NO, it can work as a neuromodulator or it can be toxic in the CNS (Cudeiro and Rivadulla 1999). In our previous papers, cell survival signals of phospho-Akt and phospho-Bad are rapidly upregulated in the goldfish RGCs 2-5 days, whereas the survival signals are rapidly downregulated in the rat RGCs 2-5 days after axotomy (Koriyama et al. 2006, Homma et al. 2007). In coupled with these results, the expression balance in NOS isoforms, particularly in the nNOS and iNOS, might be an importance for determining the neuroprotective or

1
2
3
4 neurodegenerative fate of CNS neurons after nerve injury.

5
6 The expression of nNOS is generally regulated by various pathological conditions such
7
8 as nerve injury and hypoxia via transcriptional activation of c-Jun (Vizzard 1997, Prabhakar et
9
10 al. 1996, Herdegen et al. 1993). The expression of nNOS can also be induced by many
11
12 extracellular factors, such as nerve growth factor (Schonhoff et al. 2001), brain-derived
13
14 neurotrophic factor, NT-3 and NT-4 (Huber et al. 1995), and retinoic acid (Ogura et al. 1996,
15
16 Ghigo et al.1998) in neurons and basic fibroblast growth factor in both neurons (Wen et al.
17
18 1995) and glial cells (Blanco et al. 2000). As for retinoic acid, we have recently showed that
19
20 retinoic acid signaling was involved in the early stage of optic nerve regeneration (Nagashima
21
22 et al. 2009). Levels of retinaldehyde dehydrogenase 2 (RALDH 2) mRNA rapidly increased
23
24 and peaked in the goldfish RGCs at 7-10 days after optic nerve lesion. The induction peak of
25
26 RALDH2 is a little bit earlier than that of nNOS (at 20 days after axotomy). Therefore
27
28 retinoic acid may be a candidate molecule for regulation of nNOS induction. We need further
29
30 experiments to elucidate it.
31
32
33
34
35
36
37

38 *NO-cGMP cascade on neurite outgrowth from adult goldfish injured retina.*

39
40 In the retinal explant culture system, NO donors and dbcGMP dose-dependently enhanced
41
42 neurite outgrowth for 5 days. Conversely, NOS inhibitor, sGC inhibitor and PKG inhibitor
43
44 significantly suppressed neurite outgrowth about 40% of control. The neurite outgrowing cells
45
46 in the retinal explant culture were found to be only RGCs (Johns et al. 1978). The outgrowth
47
48 of neurites from RGCs was further confirmed by anti-GAP43 immunohistochemistry (Fig. 4E,
49
50 Kaneda et al. 2008). A specific nNOS inhibitor, ETPI and a siRNA against nNOS gene
51
52 significantly and effectively suppressed the neurite outgrowth. Although the NO donor
53
54 replaced the suppression of neurite outgrowth by L-NAME, dbcGMP replaced the
55
56 suppression of neurite outgrowth by ODQ, however, the NO donor did not replaced the
57
58 suppression of neurite outgrowth by Rp-cGMPS. These results strongly support the
59
60

1
2
3
4 involvement of NO-cGMP signaling on neurite outgrowth in the injured goldfish RGCs. The
5
6 data also support the stream of NO-cGMP signaling cascade from initial nNOS to final PKG
7
8 activation (Fig. 10). By using a specific NO scavenger, c-PTIO in combination with NO
9
10 generator, NOR2, we could determine the time of switching on this signal. The switching time
11
12 is 3-6 hrs after NOR2 stimulation, because the addition of c-PTIO 3-6 h after NOR2 treatment
13
14 did not block the neurite outgrowth (Fig.5).
15
16

17
18 IBMX, a PDE inhibitor, did not evoke any neurite outgrowth in retinal explant culture
19
20 and IBMX plus SNAP did not have any additive effect on neurite outgrowth as compared
21
22 with that of SNAP alone (Fig.7). These results further suggest that the neurite outgrowth from
23
24 the injured goldfish RGCs is due to cGMP but not to cAMP (Tsukada et al. 2002). Baldrige
25
26 and Fischer (2001) reported that the IBMX and SNAP at the same concentration in our study
27
28 induced positive immunoreactivity of cGMP in the goldfish RGCs, but IBMX alone did not
29
30 induce any cGMP immunoreactivity in the retina. In the explant culture system, retina is
31
32 certainly composed of neuronal and non-neuronal cells. The fact that NO-cGMP related
33
34 agents used have no effect upon cell survival or cell death in this experimental condition as
35
36 shown in Fig. 8 further supports the neuroregenerative action of NO generation after optic
37
38 nerve injury. We have no data of NOS activation in the Müller glia in the goldfish retina after
39
40 axotomy (Fig.1). Therefore, it can be concluded that NO generation in the fish retina after
41
42 optic nerve injury is different in properties from that in rat (Koeberle and Ball, 1999,
43
44 Kawasaki et al. 2000). Taken together, the data strongly indicate that nNOS activation works
45
46 as promotion of neurite outgrowth from the injured RGCs through NO-cGMP-PKG signaling,
47
48 but not protein S-nitrosylation (Stroissnigg et al. 2007) in the goldfish RGCs after optic nerve
49
50 lesion. Intraocular dbcGMP also promoted optic nerve regeneration *in vivo* (Fig. 9).
51
52
53
54
55

56
57 In summary, we report for the first time the nNOS induction leading to promotion of
58
59 neurite outgrowth in the goldfish retina after optic nerve injury. The neurite outgrowth from
60
the injured RGCs was significantly promoted by stimulation of NO-cGMP signaling

1
2
3
4 molecules. Therefore, we conclude that NO-cGMP signaling pathway plays a key role for
5
6 optic nerve regeneration in goldfish.
7
8
9

10 **Acknowledgement**

11
12 We also thank Ms Tami Urano, Ms Tomoko Kano and Ms Sachiko Higashi for administrative
13 and technical assistance. This work was partly supported by research grants from Ministry of
14 Education, Science, Sports and Culture (Nos 1602721, 18209053, 1965447 to SK; 19700338
15 to YK), JSPS Research Fellowships for Young Scientists (DC2-9891 to MN), the 21st
16 Century COE Program on Innovative Brain Sciences for Development, Learning and Memory,
17 Kanazawa University (to YK and MN), Mitani Scientific Foundation (to SK) and by
18 Kanazawa University Awards for Young Scientist to YK (2006, 2007, 2008).
19
20
21
22
23
24
25
26
27
28
29
30
31
32
33
34
35
36
37
38
39
40
41
42
43
44
45
46
47
48
49
50
51
52
53
54
55
56
57
58
59
60

References

- 1
2
3
4
5
6 Alderton W. K., Cooper C. E. and Knowles R. G. (2001) Nitric oxide synthases: structure,
7
8 function and inhibition. *Biochem. J.* **357**, 593-615.
9
10
11 Baldrige W. H. and Fischer A. J. (2001). Nitric oxide donor stimulated increase of cyclic
12
13 GMP in the goldfish retina. *Vis. Neurosci.* **18**, 849-856.
14
15
16 Barthel L. K. and Raymond P. A. (1993) Subcellular localization of alphas-tubulin and opsin
17
18 mRNA in the goldfish retina using digoxigeninlabeled cRNA probes detected by
19
20 alkaline phosphatase and HRP histochemistry. *J. Neurosci. Methods* **50**, 145–152.
21
22
23 Blanco R. E., López-Roca A., Soto J. and Blagburn J. M. (2000) Basic fibroblast growth
24
25 factor applied to the optic nerve after injury increases long-term cell survival in the frog
26
27 retina. *J. Comp. Neurol.* **423**, 646-658.
28
29
30 Cogen J. and Cohen-Cory S. (2000) Nitric oxide modulates retinal ganglion cell axon arbor
31
32 remodeling in vivo. *J. Neurobiol.* **45**, 120-133.
33
34
35 Cudeiro J. and Rivadulla C. (1999) Sight and insight--on the physiological role of nitric oxide
36
37 in the visual system. *Trends Neurosci.* **22**, 109-116.
38
39
40 Dawson T. M., Brecht D. S., Fotuhi M., Hwang P. M. and Snyder S. H. (1991) Nitric oxide
41
42 synthase and neuronal NADPH diaphorase are identical in brain and peripheral tissues.
43
44 *Proc. Natl Acad. Sci. USA* **88**, 7797-7801.
45
46
47 Devadas M., Liu Z., Kaneda M., Arai K., Matsukawa T. and Kato S. (2001) Changes in
48
49 NADPH diaphorase expression in the fish visual system during optic nerve regeneration
50
51 and retinal development. *Neurosci. Res.* **40**, 359-365.
52
53
54 Estévez A. G., Spear N., Thompson J. A., Cornwell T. L., Radi R., Barbeito L. and Beckman J.
55
56 S. (1998) Nitric oxide-dependent production of cGMP supports the survival of rat
57
58 embryonic motor neurons cultured with brain-derived neurotrophic factor. *J. Neurosci.*
59
60 **18**, 3708-3714.

Garthwaite G., Goodwin D. A. and Garthwaite J. (1999) Nitric oxide stimulates cGMP

1
2
3
4 formation in rat optic nerve axons, providing a specific marker of axon viability. *Eur.*
5
6 *J. Neurosci.* **11**, 4367-4372.

7
8 Ghigo D., Priotto C., Migliorino D., Geromin D., Franchino C., Todde R., Costamagna C.,
9
10 Pescarmona G. and Bosia A. J. (1998) Retinoic acid-induced differentiation in a human
11
12 neuroblastoma cell line is associated with an increase in nitric oxide synthesis. *Cell*
13
14 *Physiol.* **174**, 99-106.

15
16
17
18 Goureau O., Régnier-Ricard F. and Courtois Y. (1999) Requirement for nitric oxide in retinal
19
20 neuronal cell death induced by activated Müller glial cells. *J. Neurochem.* **72**,
21
22 2506-2515.

23
24
25 Grafstein B. (1975) The nerve cell body response to axotomy. *Exp. Neurol.* **48**, 32-51.

26
27 Grafstein B. and Ingoglia N. A. (1982) Intracranial transection of the optic nerve in adult
28
29 mice: preliminary observations. *Exp. Neurol.* **76**, 318-330.

30
31
32 Green L. C., Wagner D. A., Glogowski J., Skipper P. L., Wishnok J. S. and Tannenbaum S. R.
33
34 (1982) Analysis of nitrate, nitrite, and [15N]nitrate in biological fluids. *Anal. Biochem.*
35
36 **126**, 131-138.

37
38
39 Herdegen T., Brecht S., Mayer B., Leah J., Kummer W., Bravo R. and Zimmermann M.
40
41 (1993) Long-lasting expression of JUN and KROX transcription factors and nitric oxide
42
43 synthase in intrinsic neurons of the rat brain following axotomy. *J. Neurosci.* **13**,
44
45 4130-4145.

46
47
48 Homma K., Koriyama Y., Mawatari K., Higuchi Y., Kosaka J. and Kato S. (2007) Early
49
50 downregulation of IGF-I decides the fate of rat retinal ganglion cells after optic nerve
51
52 injury. *Neurochem. Int.* **50**, 741-748.

53
54
55 Huber K. A., Krieglstein K. and Unsicker K. (1995) The neurotrophins BDNF, NT-3 and -4,
56
57 but not NGF, TGF-beta 1 and GDNF, increase the number of
58
59 NADPH-diaphorase-reactive neurons in rat spinal cord cultures. *Neuroscience.* **69**,
60
771-779.

- 1
2
3
4 Johns P. R., Heacock A. M. and Agranoff B. W. (1978) Neurites in explant cultures of adult
5
6 goldfish retina derived from ganglion cells. *Brain Res.* **142**, 531-537.
7
8
9 Kaneda M., Nagashima M. and Kato S. (2008) Changes of phospho-growth-associated
10
11 protein 43 (phospho-GAP43) in the zebrafish retina after optic nerve injury: a long-term
12
13 observation. *Neurosci. Res.* **61**, 281-288.
14
15
16 Kato S., Devadas M., Okada K., Shimada Y., Ohkawa M., Muramoto K., Takizawa N. and
17
18 Matsukawa T. (1999) Fast and slow recovery phases of goldfish behavior after
19
20 transection of the optic nerve revealed by a computer image processing system.
21
22 *Neuroscience* **93**, 907-914.
23
24
25 Kato S., Koriyama Y., Matsukawa T. and Sugitani K. (2007) Optic nerve regeneration in
26
27 goldfish. In: Becker C. G., Becker T. (Eds), *Model Organisms in Spinal Cord*
28
29 *Regeneration.* Wiley-VCH, Weinheim, pp. 355-372.
30
31
32 Kawasaki A., Otori Y. and Barnstable C. J. (2000) Müller cell protection of rat retinal
33
34 ganglion cells from glutamate and nitric oxide neurotoxicity. *Invest. Ophthalmol. Vis. Sci.*
35
36 **41**, 3444-3450.
37
38
39 Koeberle P. D. and Ball A. K. (1999) Nitric oxide synthase inhibition delays axonal
40
41 degeneration and promotes the survival of axotomized retinal ganglion cells. *Exp.*
42
43 *Neurol.* **158**, 366-381.
44
45
46 Koistinaho J. and Sagar S. M. (1995) NADPH-diaphorase-reactive neurons in the retina. *Prog.*
47
48 *Retin. Eye Res.* **15**, 69-87.
49
50
51 Komminoth P. (1992) Digoxigenin as an alternative probe labeling for in situ hybridization.
52
53 *Diagn. Mol. Pathol.* **1**, 142-150.
54
55
56 Koriyama Y., Chiba K. and Mohri T. (2003) Propentofylline protects beta-amyloid
57
58 protein-induced apoptosis in cultured rat hippocampal neurons. *Eur. J. Pharmacol.*
59
60 **458**, 235-241.
- Koriyama Y., Homma K. and Kato S. (2006) Activation of cell survival signals in the goldfish

- 1
2
3
4 retinal ganglion cells after optic nerve injury. *Adv. Exp. Med. Biol.* **572**, 333-337.
- 5
6 Koriyama Y., Homma K., Sugitani K., Higuchi Y., Matsukawa T., Murayama D. and Kato S.
7
8 (2007) Upregulation of IGF-I in the goldfish retinal ganglion cells during the early stage
9
10 of optic nerve regeneration. *Neurochem. Int.* **50**, 749-756.
- 11
12 Koriyama Y., Tanii H., Ohno M., Kimura T. and Kato S. (2008) A novel neuroprotective role
13
14 of a small peptide from flesh fly, 5-S-GAD in the rat retina in vivo. *Brain Res.* **1240**,
15
16 196-203.
- 17
18
19 Landreth G. E. and Agranoff B. W. (1976) Explant culture of adult goldfish retina: effect of
20
21 prior optic nerve crush. *Brain Res.* **118**, 299-303.
- 22
23
24 Lee E. J., Kim K. Y, Gu T. H., Moon J. I., Kim I. B., Lee M. Y., Oh S. J. and Chun M. H.
25
26 (2003) Neuronal nitric oxide synthase is expressed in the axotomized ganglion cells of
27
28 the rat retina. *Brain Res.* **986**, 174-180.
- 29
30
31 Liepe B. A., Stone C., Koistinaho J. and Copenhagen D. R. (1994) Nitric oxide synthase in
32
33 Müller cells and neurons of salamander and fish retina. *J. Neurosci.* **14**, 7641-7654.
- 34
35
36 Matsukawa T., Sugitani K., Mawatari K., Koriyama Y., Liu Z., Tanaka M. and Kato S. (2004)
37
38 Role of purpurin as a retinol-binding protein in goldfish retina during the early stage of
39
40 optic nerve regeneration: its priming action on neurite outgrowth. *J. Neurosci.* **24**,
41
42 8346-8353.
- 43
44
45 Nagashima M., Sakurai H., Mawatari K., Koriyama Y., Matsukawa T. and Kato S. (2009)
46
47 Involvement of retinoic acid signaling in goldfish optic nerve regeneration. *Neurochem.*
48
49 *Int.* **54**, 229-236.
- 50
51
52 Neufeld A. H. (1999) Nitric oxide: a potential mediator of retinal ganglion cell damage in
53
54 glaucoma. *Surv. Ophthalmol.* **43**, 129-135.
- 55
56
57 Ogura T., Nakayama K., Fujisawa H. and Esumi H. (1996) Neuronal nitric oxide synthase
58
59 expression in neuronal cell differentiation. *Neurosci. Lett.* **204**, 89-92.
- 60
Posada A. and Clarke P. G. (1999) Role of nitric oxide in a fast retrograde signal during

- 1
2
3
4 development. *Brain Res. Dev. Brain Res.* **114**, 37-42.
- 5
6 Prabhakar N. R., Rao S., Premkumar D., Pieramici S. F., Kumar G. K. and Kalaria R. K.
7
8 (1996) Regulation of neuronal nitric oxide synthase gene expression by hypoxia. Role of
9
10 nitric oxide in respiratory adaptation to low pO₂. *Adv. Exp. Med. Biol.* **410**, 345-348.
- 11
12 Schonhoff C. M., Bulseco D. A., Brancho D. M., Parada L. F. and Ross A. H. (2001) The
13
14 Ras-ERK pathway is required for the induction of neuronal nitric oxide synthase in
15
16 differentiating PC12 cells. *J. Neurochem.* **78**, 631-639.
- 17
18
19 Sperry R. W. (1948) Patterning of central synapses in regeneration of the optic nerve in
20
21 teleosts. *Physiol. Zool.* **21**, 351-361.
- 22
23
24 Stroissnigg H., Trancíková A., Descovich L., Fuhrmann J., Kutschera W., Kostan J, Meixner
25
26 A., Nothias F., and Propst F. (2007) S-nitrosylation of microtubule-associated protein
27
28 1B mediates nitric-oxide-induced axon retraction. *Nat. Cell Biol.* **9**, 1035-1045.
- 29
30
31 Sugitani K., Matsukawa T., Koriyama Y., Shintani T., Nakamura T., Noda M. and Kato S.
32
33 (2006) Upregulation of retinal transglutaminase during the axonal elongation stage of
34
35 goldfish optic nerve regeneration. *Neuroscience* **142**, 1081-1092.
- 36
37
38 Tsukada S., Keino-Masu K., Masu M. and Fukuda J. (2002) Activation of protein kinase A by
39
40 nitric oxide in cultured dorsal root ganglion neurons of the rat, examined by a
41
42 fluorescence probe, ARII. *Neurosci. Lett.* **318**, 17-20.
- 43
44
45 Verge V. M., Xu Z., Xu X. J., Wiesenfeld-Hallin Z. and Hökfelt T. (1992) Marked increase in
46
47 nitric oxide synthase mRNA in rat dorsal root ganglia after peripheral axotomy: in situ
48
49 hybridization and functional studies. *Proc. Natl Acad. Sci. USA* **89**, 11617-11621.
- 50
51
52 Villegas-Pérez M. P., Vidal-Sanz M., Rasminsky M., Bray G. M. And Aguayo A. J. (1993)
53
54 Rapid and protracted phases of retinal ganglion cell loss follow axotomy in the optic
55
56 nerve of adult rats. *J. Neurobiol.* **24**, 23-36.
- 57
58
59 Vizzard M. A. 1997 Increased expression of neuronal nitric oxide synthase in bladder afferent
60
and spinal neurons following spinal cord injury. *Dev. Neurosci.* **19**, 232-246.

- 1
2
3
4 Weiler R. and Kewitz B. (1993) The marker for nitric oxide synthase, NADPH-diaphorase,
5
6 co-localizes with GABA in horizontal cells and cells of the inner retina in the carp retina.
7
8 *Neurosci. Lett.* **158**, 151-154.
9
- 10 Wen R., Song Y., Cheng T., Matthes M. T., Yasumura D., LaVail M. M. and Steinberg R. H.
11
12 (1995) Injury-induced upregulation of bFGF and CNTF mRNAs in the rat retina. *J.*
13
14 *Neurosci.* **15**, 7377-7385.
15
16
- 17 Williams C. V., Nordquist D. and McLoon S. C. (1994) Correlation of nitric oxide synthase
18
19 expression with changing patterns of axonal projections in the developing visual system.
20
21 *J. Neurosci.* **14**, 1746-1755.
22
23
- 24 Yu W. H. (1994) Nitric oxide synthase in motor neurons after axotomy. *J. Histochem.*
25
26 *Cytochem.* **42**, 451-457.
27
28
29
30
31
32
33
34
35
36
37
38
39
40
41
42
43
44
45
46
47
48
49
50
51
52
53
54
55
56
57
58
59
60

Figure legends

Fig. 1

NADPHd staining and nitrite production in the goldfish retina after optic nerve lesioning. (A-C) NADPHd staining increased primarily in the GCL 20 days after lesioning (B) compared with the control retina (A), and returned to the control level 40 days (C) after lesioning. ONL: outer nuclear layer, INL: inner nuclear layer, GCL: ganglion cell layer. Scale bar = 100 μm . (D) Nitrite production was measured in the retinas at various time points after lesioning. The concentration of nitrite increased within 5 days, peaked at 20 days, and returned to baseline 40 days after injury. * $P < 0.05$ vs. control (n=4).

Fig. 2

Upregulation of nNOS mRNA in the goldfish retina after optic nerve lesion. (A-C) *In situ* hybridization of nNOS mRNA in the goldfish retina during optic nerve regeneration. Levels of nNOS mRNA increased primarily in the GCL after 5 days and peaked at 20 days after lesioning (B) relative to the control (A). The levels of nNOS mRNA in the GCL gradually decreased thereafter up to 40 days (C) after lesioning. ONL: outer nuclear layer, INL: inner nuclear layer, GCL: ganglion cell layer. Scale bar = 100 μm .

Fig. 3

Upregulation of nNOS protein in the goldfish retina after optic nerve lesioning. (A) Western blotting analysis of nNOS protein showing a specific band at 160 kDa. * $P < 0.05$ vs. control. (n=4). (B-D) Immunoreactivity of nNOS protein increased primarily in the ganglion cell layer (GCL) at day 20 (C), relative to the control (B), and returned to basal levels by day 40 (D). ONL: outer nuclear layer, INL: inner nuclear layer. GCL: ganglion cell layer. Scale bar = 100 μm .

Fig. 4

Regulatory effect of NOS-NO related molecules upon neurite outgrowth in the goldfish retinal explant culture. (A and B) Quantitative data for NOS-NO related drugs on neurite outgrowth were obtained from axotomized goldfish retinal explant culture relative to the control (no treatment, 100%). (A) NO generator, NOR2 induced the neurite outgrowth. * $P < 0.05$ vs. control. (n=4). (B) Universal NOS inhibitor, L-NAME inhibited the neurite outgrowth. * $P < 0.05$ vs. control. (n=4). (C-H) Photomicrographs of neurite outgrowth under various conditions: (C) control. Scale bar = 100 μm , (D) 100 μM of NOR2, (E) 500 μM of SNAP, (F) immunohistochemistry of anti-GAP43 antibody in (E), (G) 400 μM of L-NAME, (H) L-NAME plus NOR2.

Fig. 5

Different application time of a NO scavenger on NO-induced neurite outgrowth.

(A) Application of c-PTIO to the culture medium at different time points after NOR2 treatment. c-PTIO application at the same time (0 h) after NOR2 treatment completely blocked the neurite outgrowth by NOR2. c-PTIO application at 3 h after NOR2 treatment slightly blocked the neurite outgrowth, but c-PTIO application at 6 h after NOR2 treatment did not block any neurite outgrowth * $P < 0.05$ vs. control. n = 4. (B-E) Photomicrographs of neurite outgrowth under various conditions. (B) Control, Scale bar = 100 μm , (C) c-PTIO at 0 h after NOR2 treatment, (D) c-PTIO at 3 h after NOR2 treatment. (E) c-PTIO at 6 h after NOR2 treatment.

Fig. 6

Neuronal NOS specificity on neurite outgrowth in the goldfish retinal explant culture. (A) The nNOS specific inhibitor, ETPI, dose-dependently inhibited neurite outgrowth from axotomized retina. * $P < 0.05$ vs. control. (n=4). (B) ETPI (40 μM). (C) Decrease in nNOS

1
2
3
4 protein level following treatment with nNOS-specific siRNA for 5 days relative to the control
5 or scrambled siRNA. *P<0.05 vs. control. (n=3). (D) The nNOS specific siRNA significantly
6 inhibited neurite outgrowth relative to the scrambled or control treatment. *P<0.05 vs. control.
7 (n=4). (E) Scrambled siRNA, (F) nNOS-specific siRNA. Scale bar = 100 μ m.
8
9
10
11
12

13
14
15 Fig. 7

16
17 Regulatory effect of cGMP related molecules upon neurite outgrowth in the retinal explant
18 culture. (A) Effect of non-specific cyclic nucleotide phosphodiesterase inhibitor, IBMX
19 and/or SNAP. *P<0.05 vs. control. (n=4). (B) Effect of dbcGMP, a membrane-permeable
20 cGMP analog. *P<0.05 vs. control. (n=4). (C) Effect of dbcGMP (200-400 μ M) and/or ODQ,
21 a sGC inhibitor (100 μ M). *P<0.05 vs. control. (n=4). (D-G) Photomicrographs of neurite
22 outgrowth under various conditions: (D) control, (E) 400 μ M of dbcGMP, (F) 100 μ M of
23 ODQ, (G) dbcGMP plus ODQ. (H) Effect of Rp-cGMPS, a PKG inhibitor and/or SNAP on
24 neurite outgrowth. *P<0.05 vs. control. (n=4). (I) 10 μ M of Rp-cGMPS. Scale bar = 100 μ m.
25
26
27
28
29
30
31
32
33
34
35
36
37

38 Fig. 8

39
40 Lacking effect of NO-cGMP related agents upon cell survival. Retinal explants were treated
41 with each agent for 5 days and then cell viability was quantified by MTT assay. (n=4).
42
43
44
45
46
47

48 Fig. 9

49
50 Cyclic GMP promotes optic nerve regeneration *in vivo*. (A, B) Regenerating nerve fibres in
51 goldfish optic nerve at 10 days after crush under intraocular injection of 2 μ l of PBS (A) or
52 dbcGMP (20 mM, B). The nerve fibres were anterogradely labeled with cholera toxin B. The
53 regenerating optic axons treated with intraocular dbcGMP more proceeded over the crush site
54 (marked with an asterisk) than those treated with PBS alone. Scale bar = 100 μ m. (C-F)
55
56
57
58
59
60
61 Number of RGCs reinnervating the tectum at 3 weeks after crush under intraocular injection

1
2
3
4 of 2 μ l of PBS (D) or dbcGMP (20 mM, E) relative to the intact control (C). Scale bar = 100
5
6 μ m. The RGCs were retrogradely labeled with FluoroGold. The number of RGCs in the
7
8 flat-mounted retina treated with dbcGMP was larger than that of RGCs treated with PBS
9
10 alone. * $P < 0.05$ vs. PBS, F).

11
12
13
14
15 Fig. 10

16
17 Schematic diagram of NO-cGMP signaling pathway and its related agents used in this study.
18
19 Optic nerve lesion initially induces nNOS expression followed by NO-cGMP signaling
20
21 activation and finally leads to optic nerve regeneration through PKG activation.
22
23
24
25
26
27
28
29
30
31
32
33
34
35
36
37
38
39
40
41
42
43
44
45
46
47
48
49
50
51
52
53
54
55
56
57
58
59
60

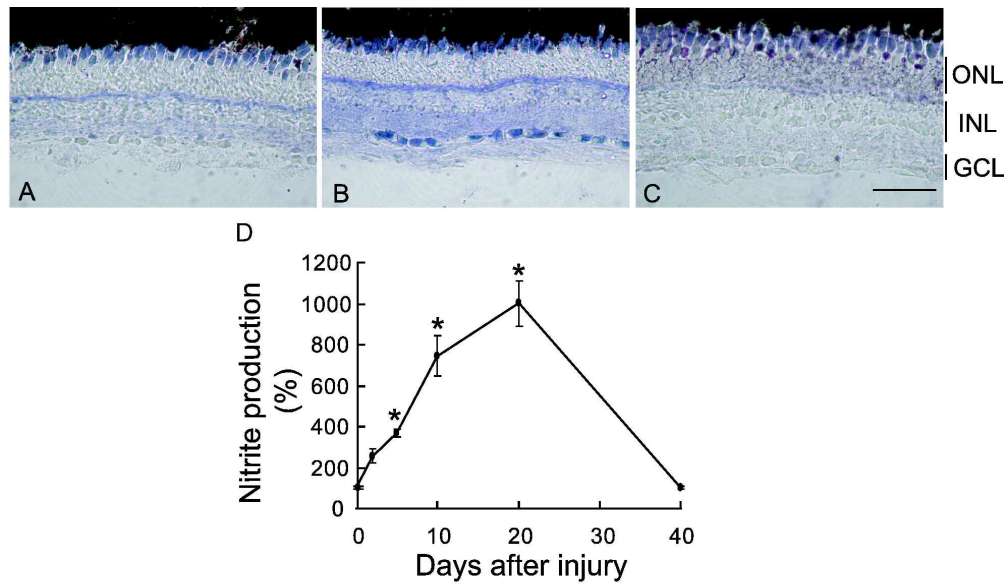

Fig.1

167x104mm (600 x 600 DPI)

Peer Review

1
2
3
4
5
6
7
8
9
10
11
12
13
14
15
16
17
18
19
20
21
22
23
24
25
26
27
28
29
30
31
32
33
34
35
36
37
38
39
40
41
42
43
44
45
46
47
48
49
50
51
52
53
54
55
56
57
58
59
60

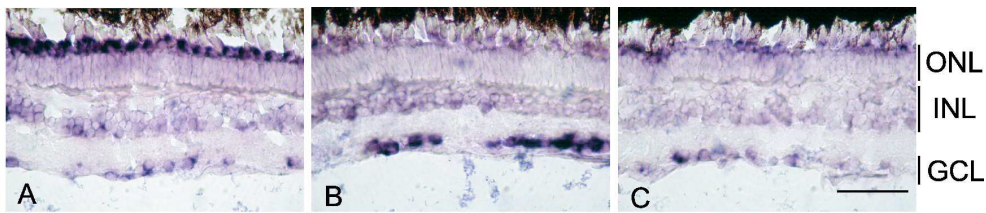

Fig.2

150x43mm (600 x 600 DPI)

Or Peer Review

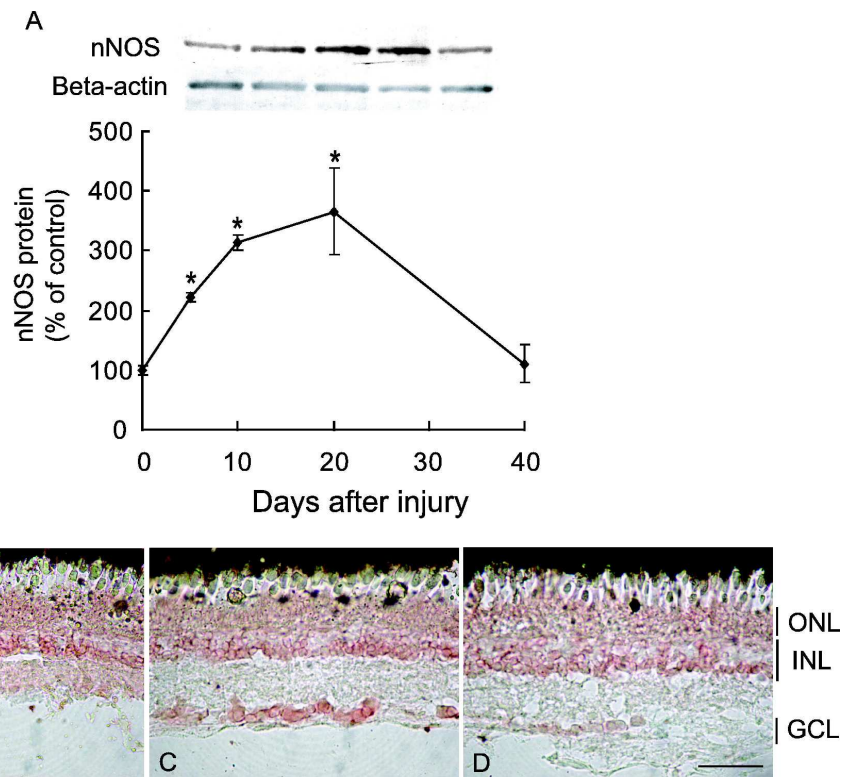

Fig.3

164x138mm (600 x 600 DPI)

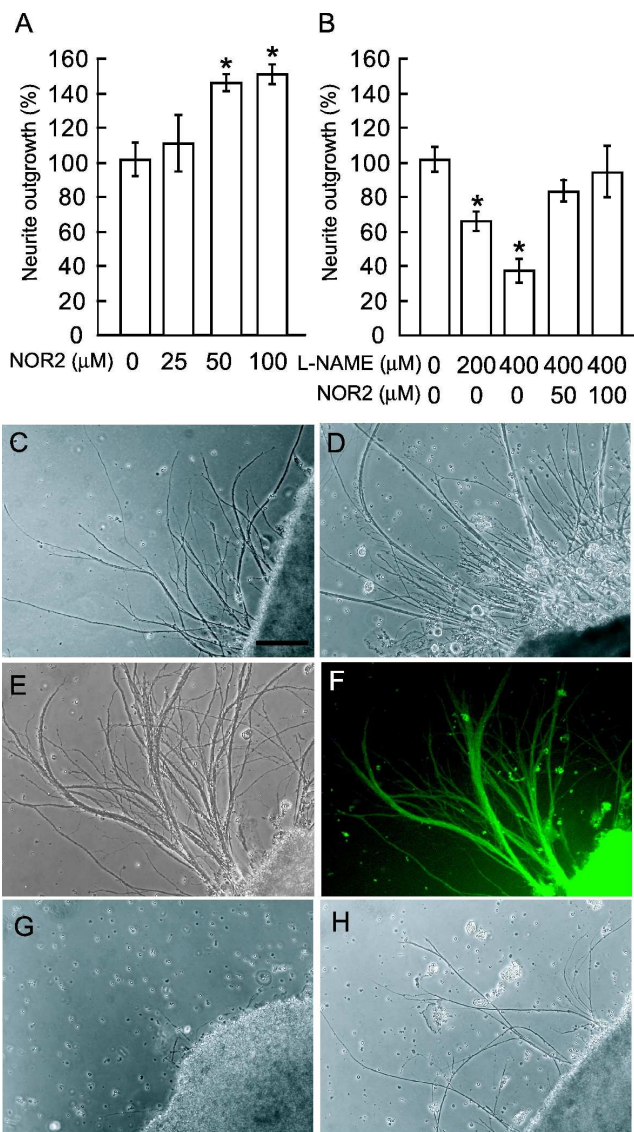
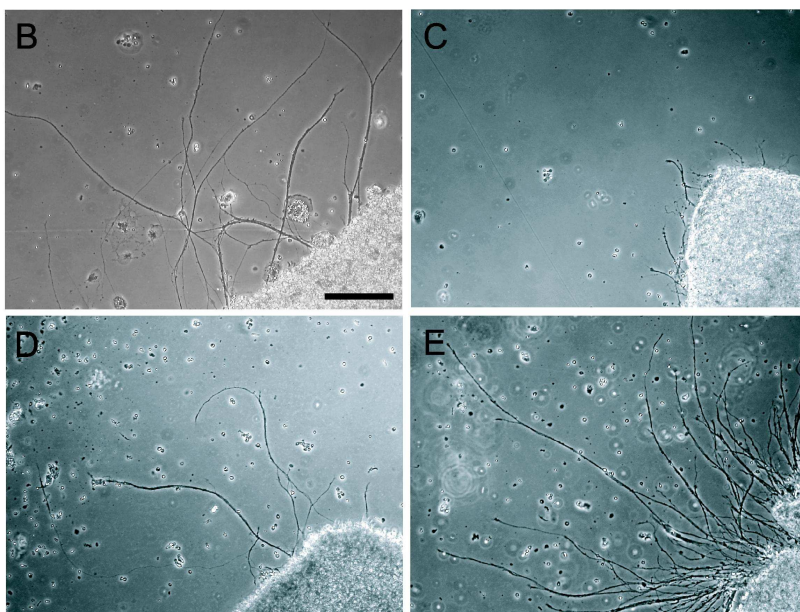
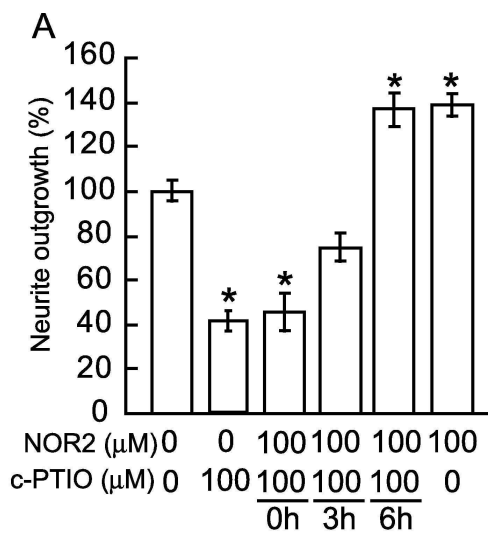

Fig.4

100x188mm (600 x 600 DPI)

1
2
3
4
5
6
7
8
9
10
11
12
13
14
15
16
17
18
19
20
21
22
23
24
25
26
27
28
29
30
31
32
33
34
35
36
37
38
39
40
41
42
43
44
45
46
47
48
49
50
51
52
53
54
55
56
57
58
59
60



45
46
47

Fig.5

48
49
50
51
52
53
54
55
56
57
58
59
60

98x145mm (600 x 600 DPI)

1
2
3
4
5
6
7
8
9
10
11
12
13
14
15
16
17
18
19
20
21
22
23
24
25
26
27
28
29
30
31
32
33
34
35
36
37
38
39
40
41
42
43
44
45
46
47
48
49
50
51
52
53
54
55
56
57
58
59
60

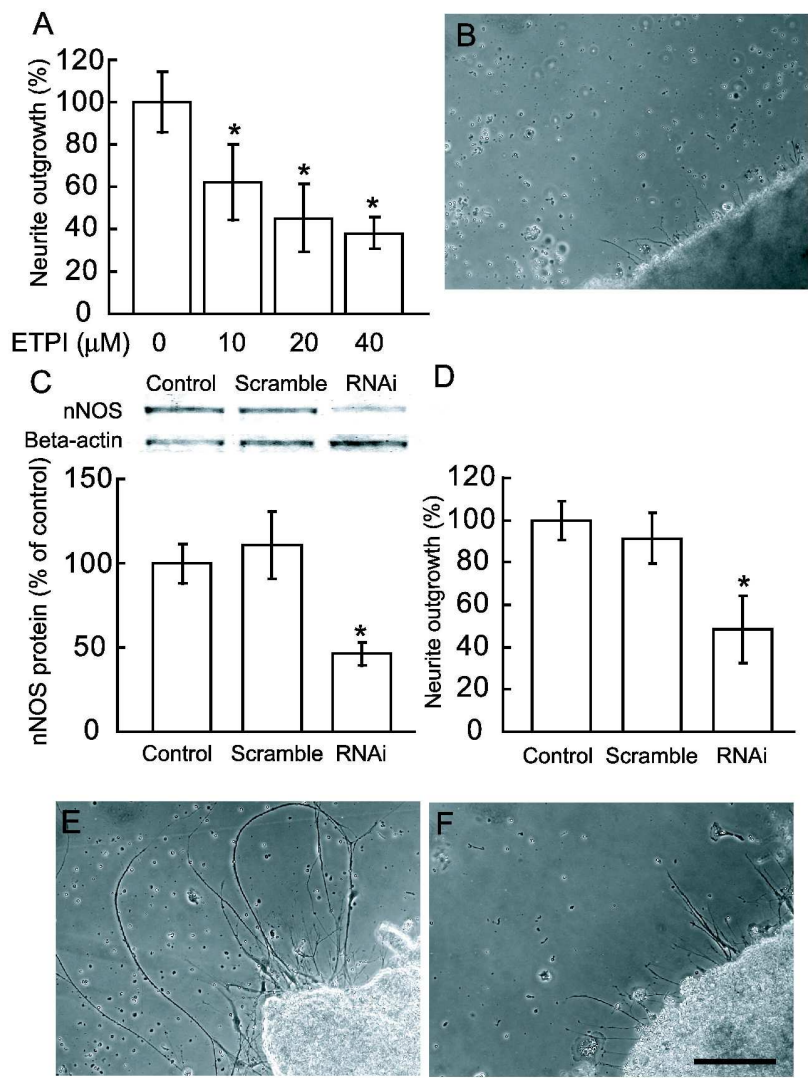

Fig.6

120x162mm (600 x 600 DPI)

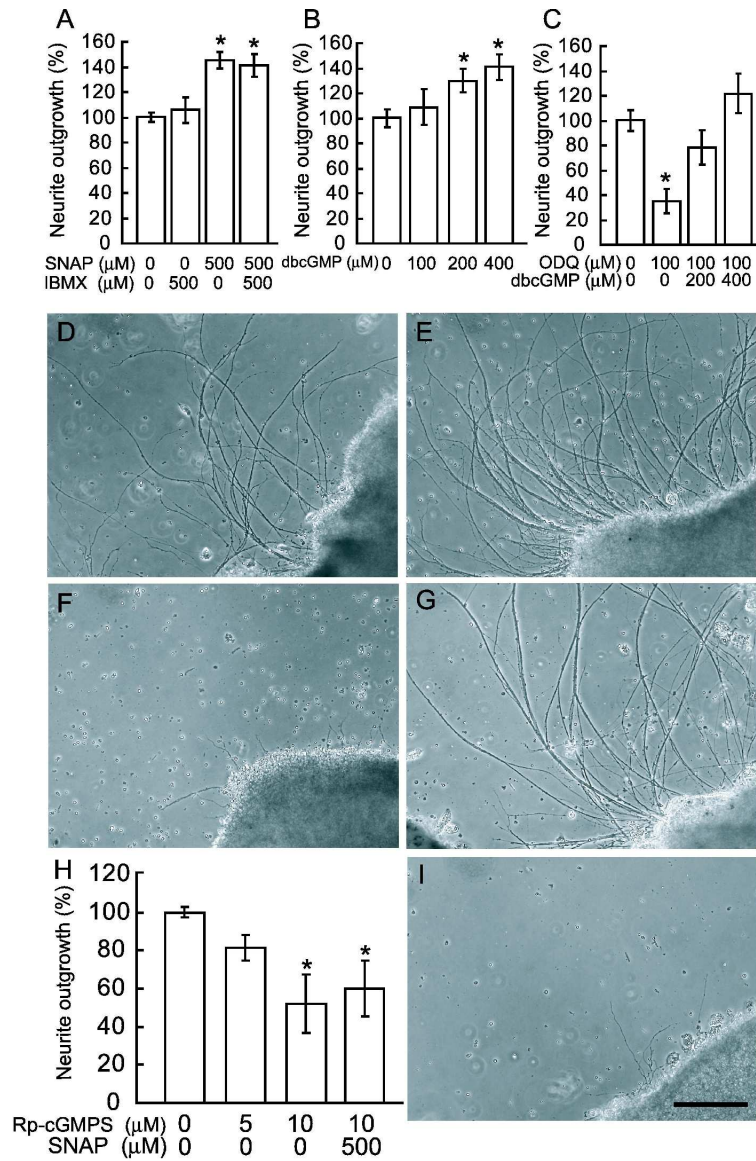

Fig.7

119x190mm (600 x 600 DPI)

1
2
3
4
5
6
7
8
9
10
11
12
13
14
15
16
17
18
19
20
21
22
23
24
25
26
27
28
29
30
31
32
33
34
35
36
37
38
39
40
41
42
43
44
45
46
47
48
49
50
51
52
53
54
55
56
57
58
59
60

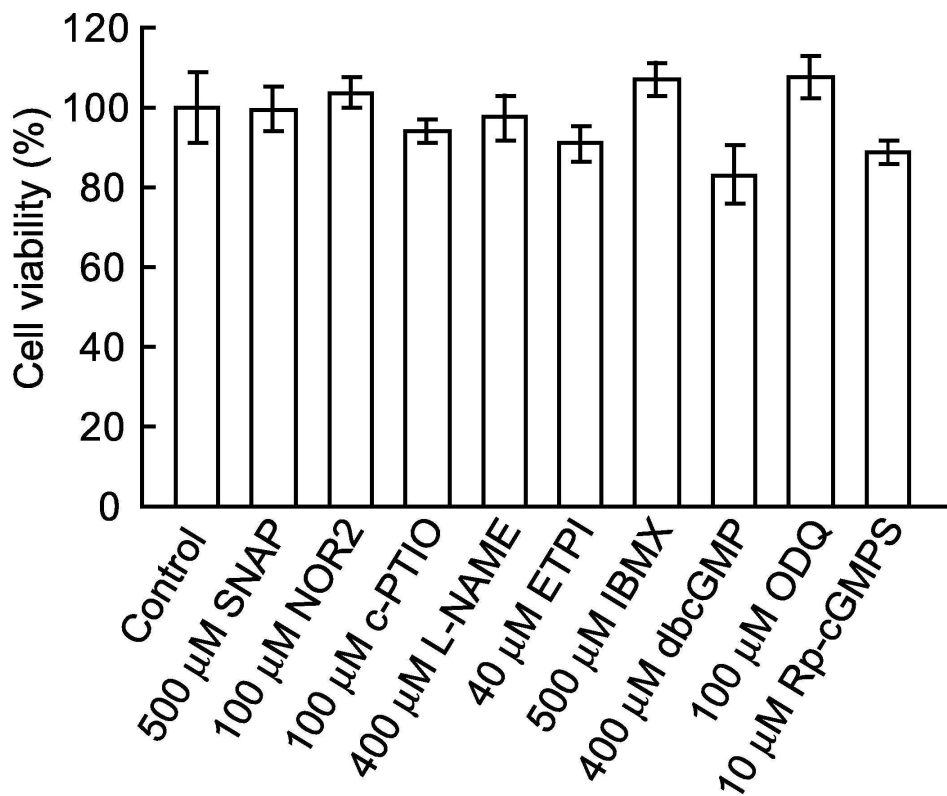

Fig.8

94x79mm (600 x 600 DPI)

iew

1
2
3
4
5
6
7
8
9
10
11
12
13
14
15
16
17
18
19
20
21
22
23
24
25
26
27
28
29
30
31
32
33
34
35
36
37
38
39
40
41
42
43
44
45
46
47
48
49
50
51
52
53
54
55
56
57
58
59
60

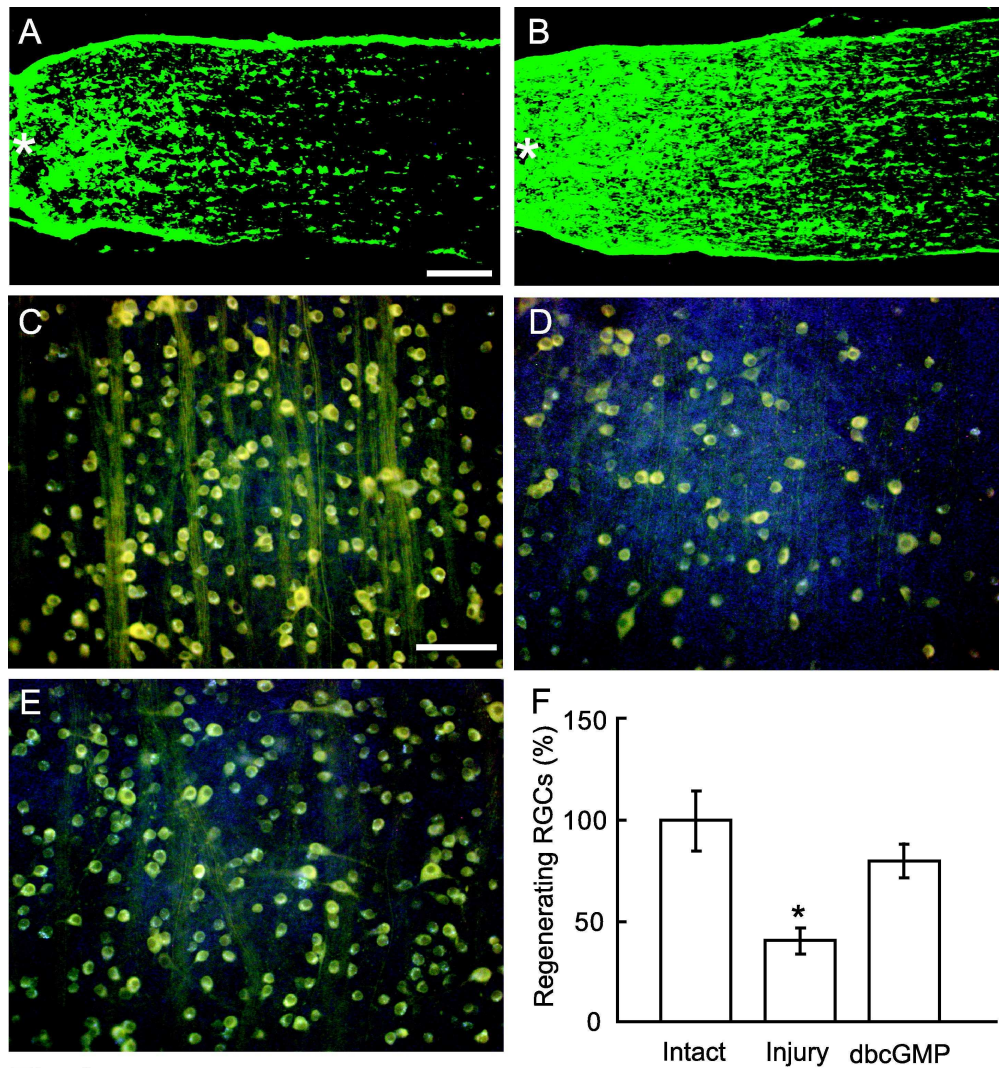

Fig.9

123x135mm (600 x 600 DPI)

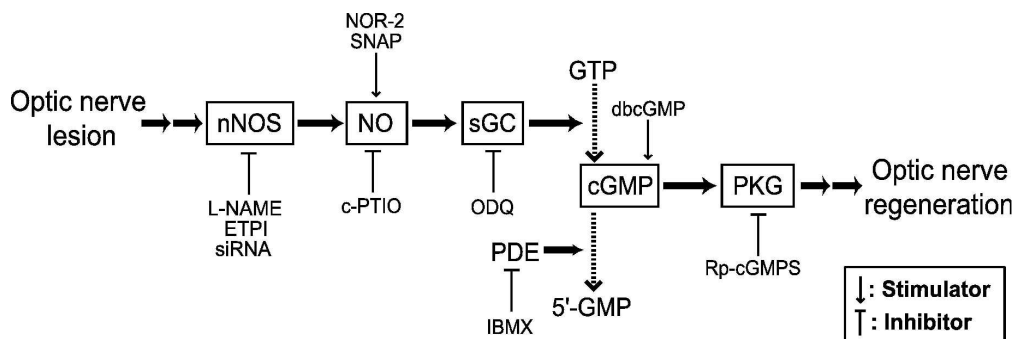

Fig.10

155x57mm (600 x 600 DPI)

Peer Review