

Conveyance test by oscillation and rotation to a permanent magnet repulsive-type conveyor

| | |
|-------|---|
| メタデータ | 言語: eng 出版者: 公開日: 2017-10-05 キーワード (Ja): キーワード (En): 作成者: メールアドレス: 所属: |
| URL | http://hdl.handle.net/2297/6904 |

Conveyance Test by Oscillation and Rotation to a Permanent Magnet Repulsive-Type Conveyor

Takahisa Ohji, Satoru Ichiyama, Kenji Amei, Masaaki Sakui, *Member, IEEE*, and Sotoshi Yamada, *Member, IEEE*

Abstract—Various applications of a single-axis controlled repulsive-type magnetic bearing have been proposed earlier. However, most conventional systems are equipped with a set of passive magnetic bearings and an active magnetic bearing. In this paper a new repulsive-type conveyor system with many passive magnetic bearing pairs is proposed. This system enables an easy rotation with negligible friction and soft conveyance by radial stiffness between the rotor and the stator permanent magnets. This paper also reports a conveyance test using ellipse motion of each shaft.

Index Terms—Conveyor, magnetic levitation, natural frequency, permanent magnets, repulsive force.

I. INTRODUCTION

ONE of the simplest methods in magnetic levitation technology is a repulsive-type magnetic levitation system using permanent magnets. Generally, it is well known that it is necessary to control at least one direction actively in order to achieve a stable noncontact condition in magnetostatic field [1], [2]. The authors have studied a single-axis controlled repulsive-type magnetic bearing using typically four cylindrical permanent magnets [3], [4]. This system has the feature of reduction of peripheral equipment and displacement sensors for active controls. Also, the radial stiffness of the system is small compared with that of the active magnetic bearings. From the above features, in recent years, turbomolecular pumps, high-speed rotational-type polygon scanner motors, and micro-mass measurement devices have been proposed as applications to the small-sized devices without a radial mechanical load [5]–[7].

Conventional applications employ only a passive magnetic levitation unit, which consists of a levitator shaft, two passive magnetic bearing sections, and so on. In this paper, the new conveyor system using many passive magnetic levitation units is proposed. Fundamental characteristics of a passive magnetic levitation unit, a driving method by generating an elliptical motion, and a conveyance test on the permanent magnet repul-



Fig. 1. Photograph of the permanent magnet repulsive-type conveyor. Nine passive magnetic levitation units are put in order.

sive-type conveyor which combined the nine units are also reported. Since there is no lubrication problem, the proposed conveyor system will be especially useful in hygienic environments and clean-room conditions.

II. CONFIGURATION AND BASIC CHARACTERISTICS

The proposed configuration of the permanent magnet repulsive-type conveyor for trial operation is shown in Fig. 1. A number of passive magnetic levitation units are arranged in order. Each levitator has both the resiliency along the load direction by repulsive forces of permanent magnets and the easy rotation by negligible friction. In particular, it is significant that there is no contact point in the radial direction unlike the ordinary mechanical conveyor, that is, neither the vertical drag force nor breaking torque to the levitator occurs at all. Figs. 2 and 3 show the configuration of the passive magnetic levitation unit, which consists of four Nd-Fe-B permanent magnets, an aluminum shaft, four electromagnets, and two positioning screws. Permanent magnets with perpendicular magnetization stabilize the levitator along the radial direction. Electromagnets are installed for changing magnetic flux density between the rotor and the stator permanent magnets. The total mass of the levitator is around 0.11 kg, the shaft length is 280 mm, and the gap length between the rotor and stator magnet is 4 mm.

Characteristics of the repulsive forces in one side's permanent magnet section are shown in Fig. 4. The negative gradient (i.e., positive stiffness), which contributes to passive stability in the radial direction, and the zero-force point in the axial direction exist simultaneously at $x = 0$ and $z = 0$. The axial positioning screws are installed in order to maintain the operating point near

Manuscript received December 2, 2003; revised December 15, 2003. This work was supported in part by the Ministry of Education, Culture, Sports, Science and Technology, Grant-in-Aid for Scientific Research, 14750203, 2002.

T. Ohji was with Kanazawa University, Kanazawa 920-8667, Japan. He is now with the Department of Electrical and Electronic Engineering, Toyama University, Toyama 930-8555, Japan (e-mail: ohji@eng.toyama-u.ac.jp).

S. Ichiyama, K. Amei, and M. Sakui are with the Department of Electrical and Electronic Engineering, Toyama University, Toyama 930-8555, Japan (e-mail: m022015@ems.toyama-u.ac.jp; amei@eng.toyama-u.ac.jp; sakui@eng.toyama-u.ac.jp).

S. Yamada is with the Institute of Nature and Environmental Technology (K-INET), Kanazawa University, Kanazawa 920-8667, Japan (e-mail: yamada@magstar.ec.t.kanazawa-u.ac.jp).

Digital Object Identifier 10.1109/TMAG.2004.832263

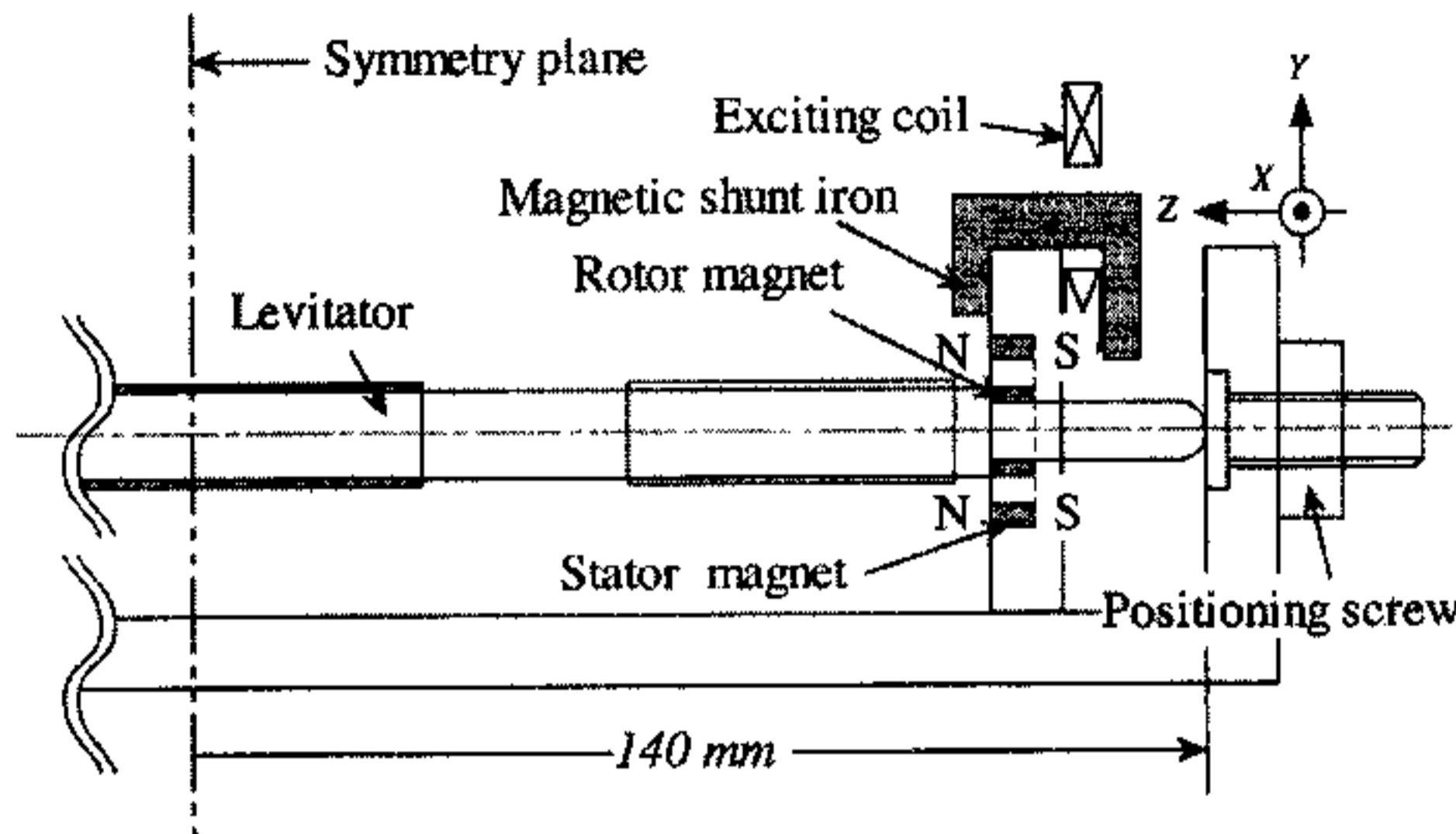

Fig. 2. Front view of the passive magnetic levitation unit. It comprises a shaft, four cylindrical permanent magnets, four electromagnets for magnetic shunt, and positioning screws.

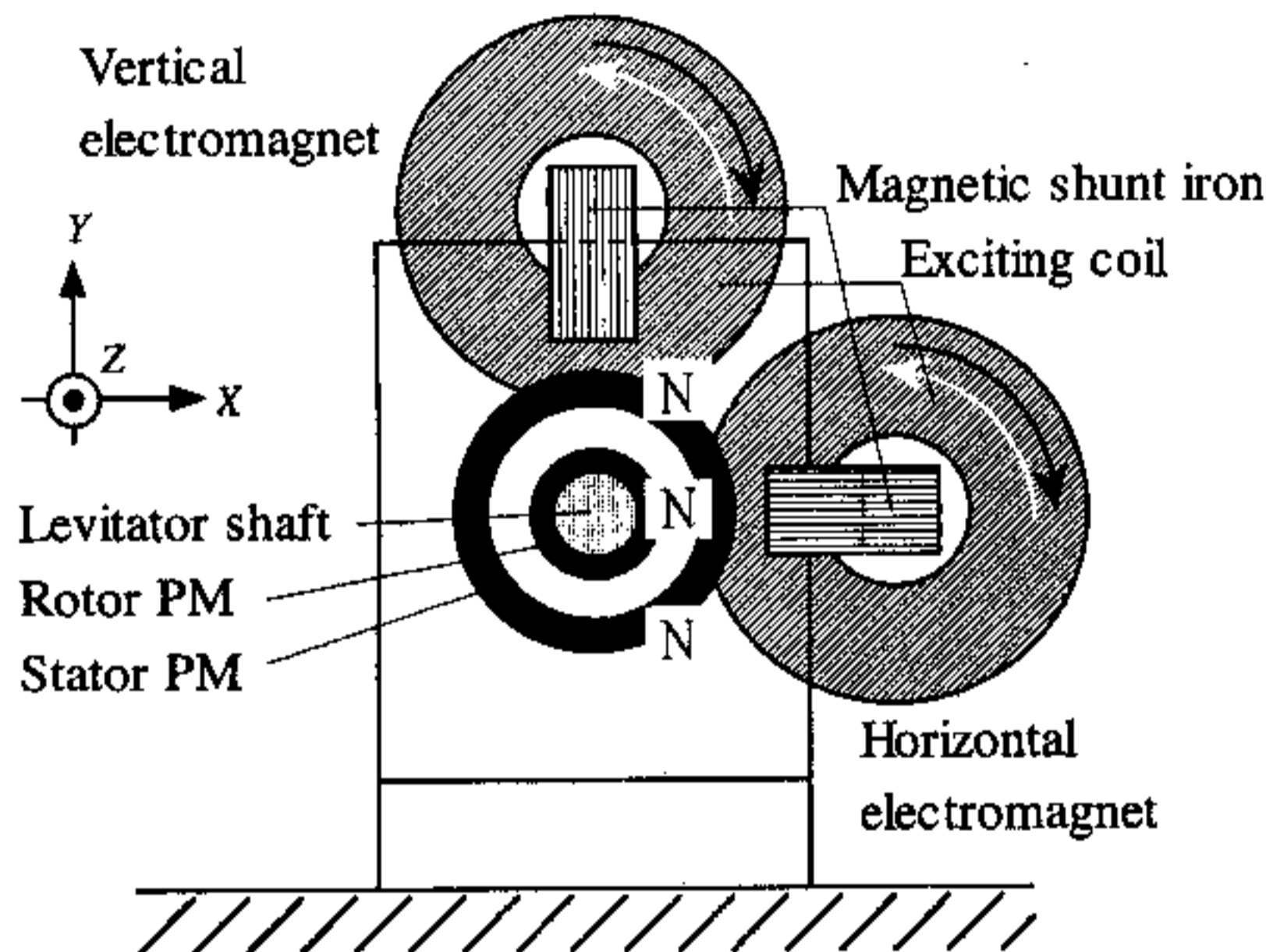

Fig. 3. Side view of the passive magnetic levitation unit seen from the symmetry plane. Two electromagnets are configured with the phase difference of 90 degrees in space.

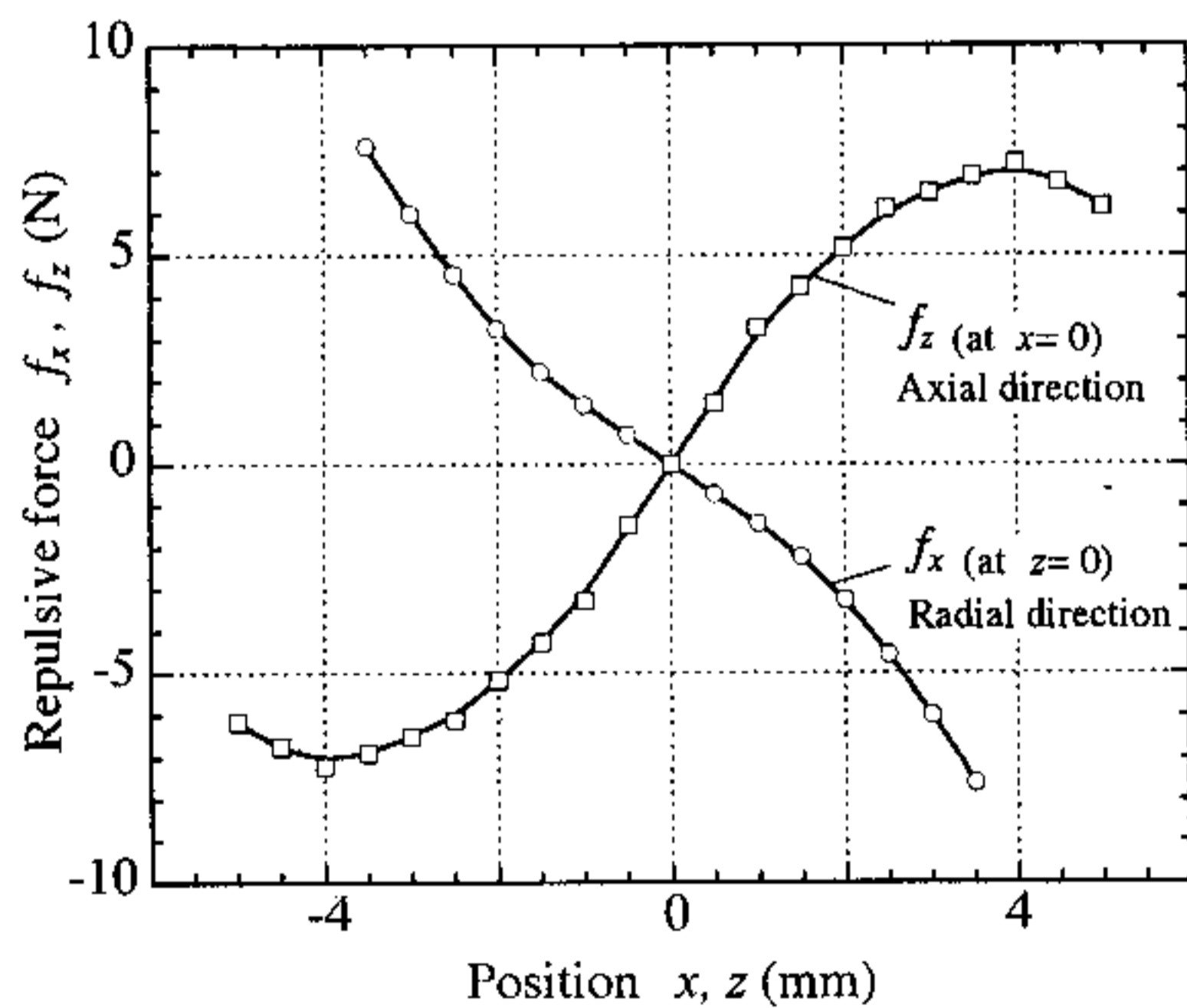

Fig. 4. Characteristics of the repulsive forces along the axial and radial directions. The point of intersection indicates the position having positive stiffness in the radial direction and zero force in the axial direction.

the point of intersection. It turns out that the radial stiffness is around 1416 N/m. Natural frequency of the levitator is calculated from the relationship between radial stiffness and levitator mass, and the calculated value is around 25 Hz. Fig. 5 shows the experimental result of the impact test. Clearly, the natural

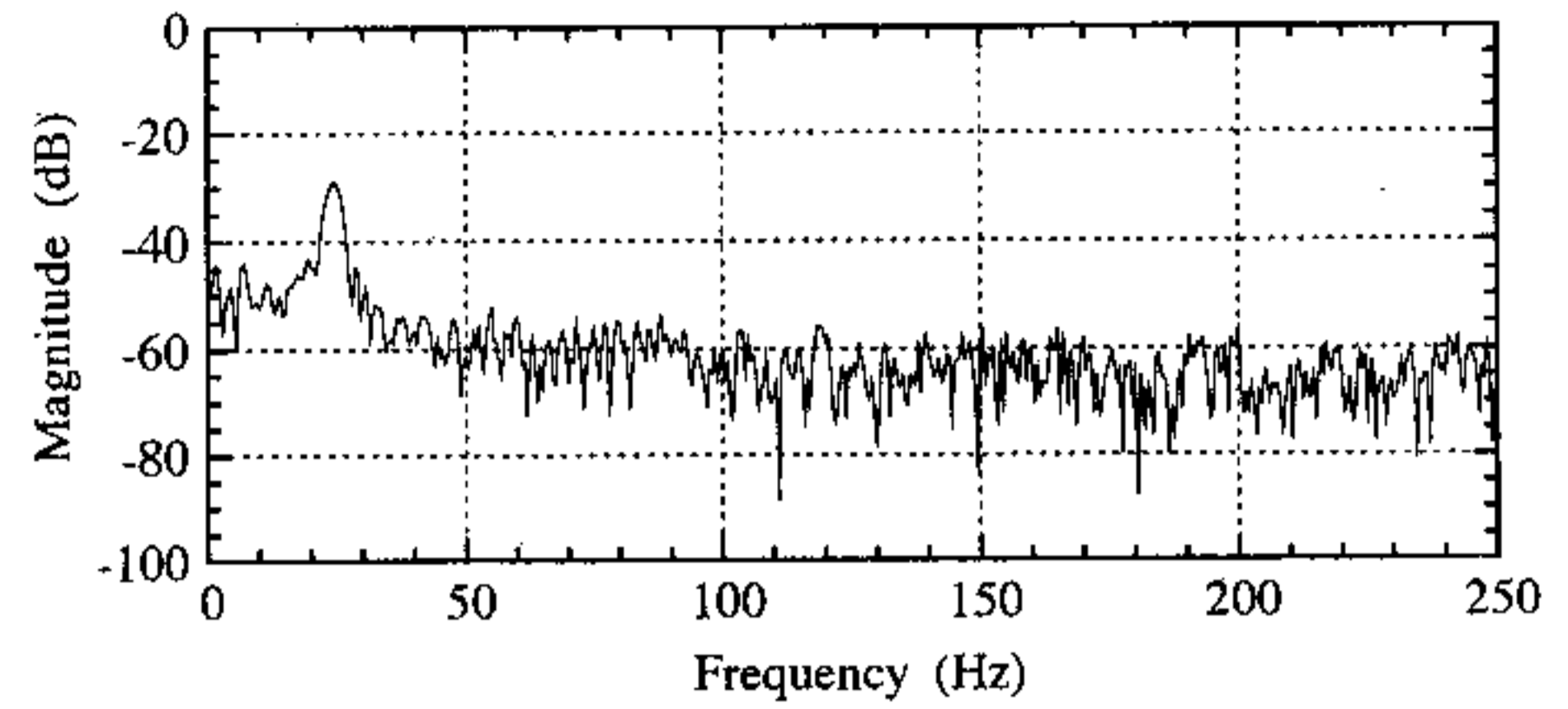

Fig. 5. Impulse response characteristics.

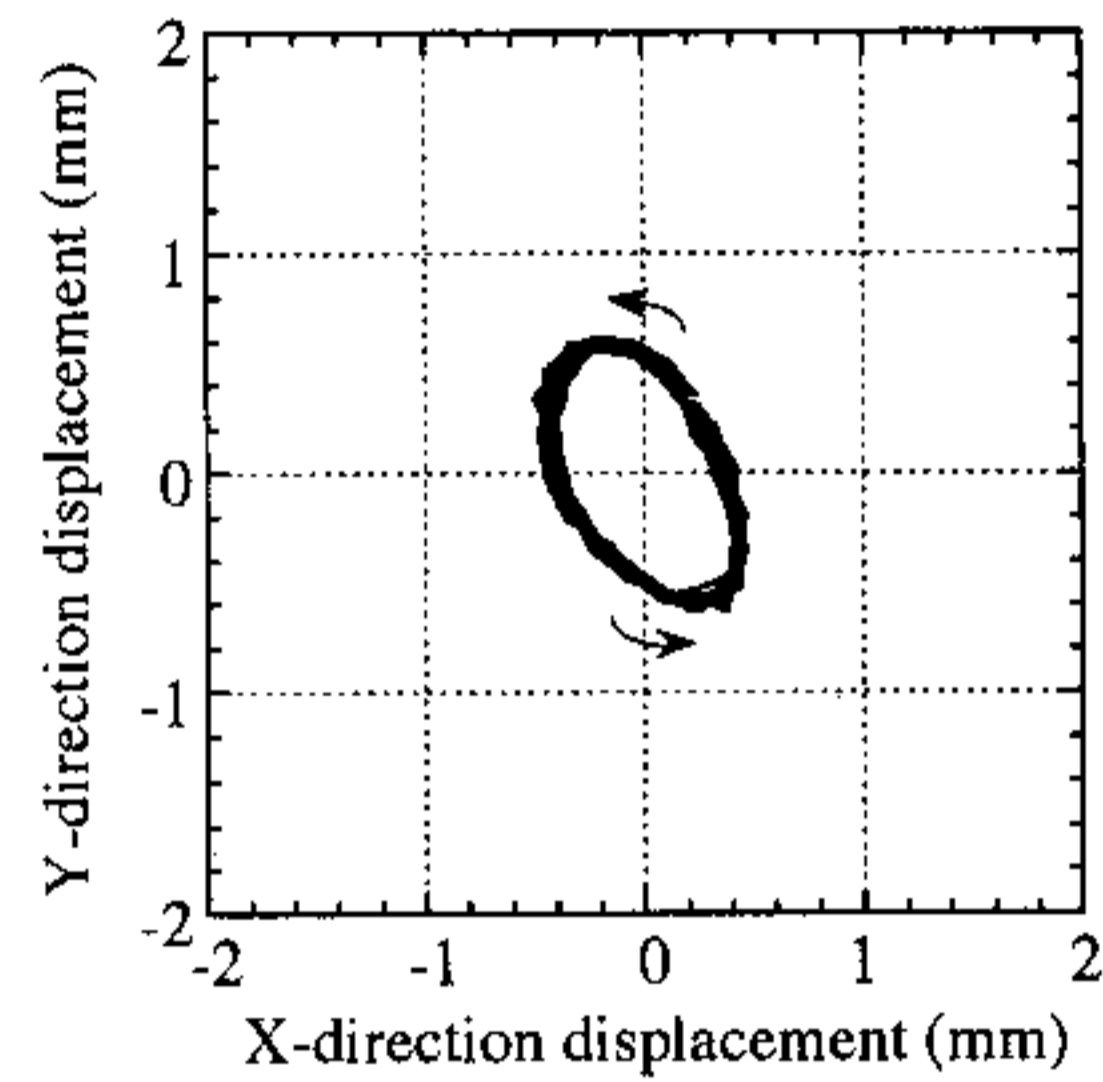

Fig. 6. Lissajous diagram of the levitator oscillated by two electromagnets. Radial repulsive force changes with two-phase ac magnetic field sequentially.

frequency exists near 25 Hz, which corresponds with the calculated value from the force characteristics shown in Fig. 4.

III. EXPERIMENTAL RESULTS

Owing to the structural advantages of the passive magnetic levitation unit, it can be operated in oscillation mode or rotation mode, or both. The conveyance test is conducted by the operational method having the oscillation and the rotation modes. Two electromagnets are used in order to obtain a phase shift of 90 degrees spatially, and to make the levitator oscillate. On application of the two-phase sinusoidal ac voltage to each electromagnet, the magnetic flux density in the air-gap increase and decrease at regular interval. In a case where the voltage of a horizontal electromagnet leads 90 degrees from that of a vertical one, the levitator moves counterclockwise, maintaining an elliptical orbit as shown in Fig. 6. The power supply frequency is adjusted to the natural frequency of the levitator in order to generate sufficient oscillation.

Fig. 7 shows schematics in a conveyance test. Two-phase ac voltage as shown in Fig. 7 is generated using variable-voltage variable-frequency (VVVF) power supply. All the levitators oscillate and rotate synchronously by connecting the coils in each direction in series. When the voltage of each phase is switched, the direction of rotation will change. For the same applied voltage and same coil connection, each shaft oscillates simultaneously as shown in Fig. 6. The shaft will rotate in the clockwise direction due to the existence of slight friction on one end of the levitator. Consequently, the conveyance movement will be along the x direction as shown in Fig. 8. An experimental result of the conveyance test by oscillation and

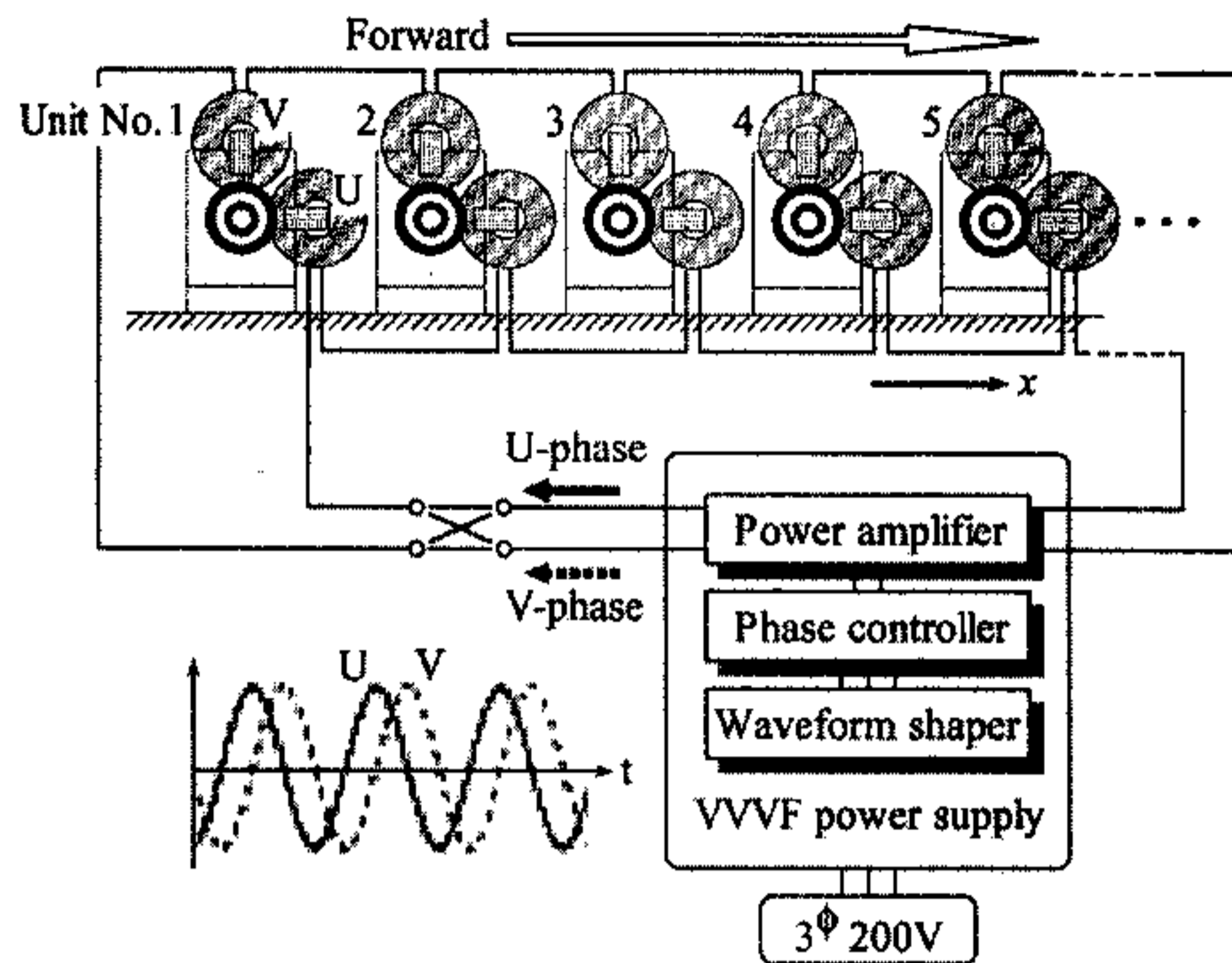

Fig. 7. Schematics in a conveyance test. By connecting the coils in each direction in series, all the levitators rotate synchronously.

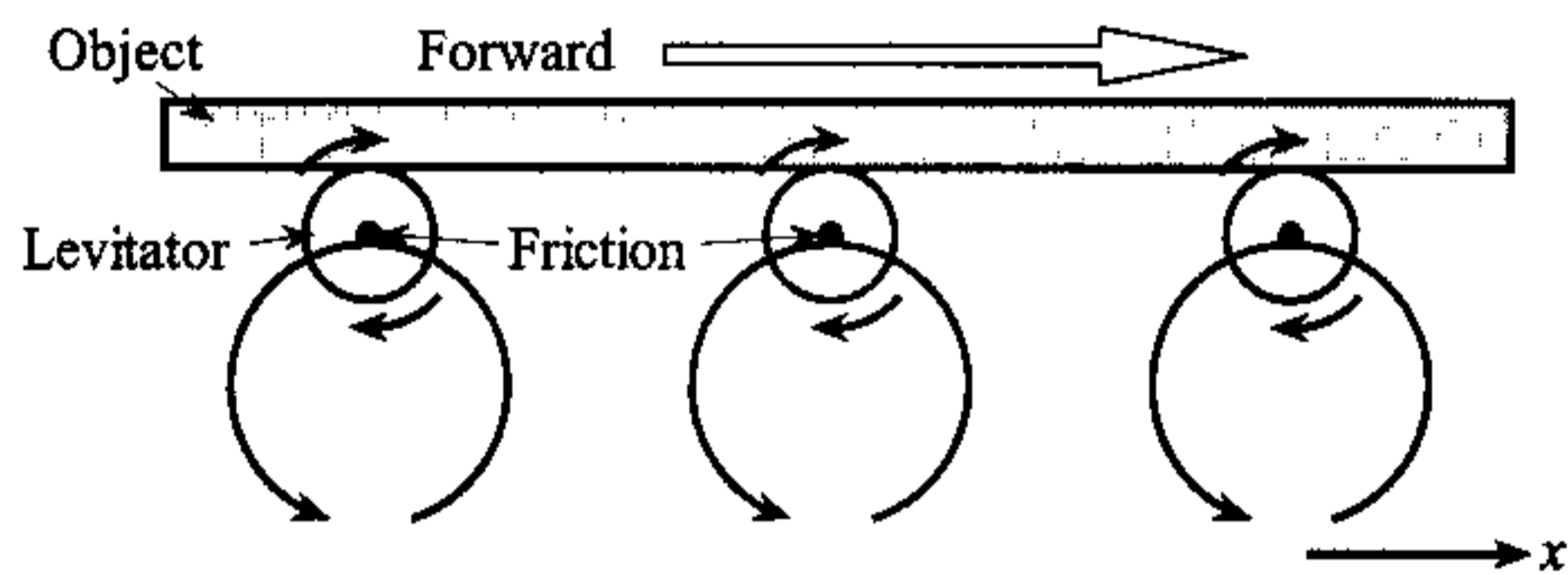

Fig. 8. The principle of operation of the conveyor system. Both rotation and revolution of the levitator have occurred simultaneously due to the slight friction.

rotation is shown in Fig. 9. A thin sponge sheet, of dimensions $250 \text{ mm} \times 160 \text{ mm} \times 10 \text{ mm}$, was used for the object on the shafts. The pitch between the levitators is 75 mm . When a thin sponge sheet is placed on the shafts, it moves by the maximum speed of 0.1 m/s . Since the number of levitators in contact with the sheet decreases, conveyance speed slows down. On phase reversal, the direction of rotation will be reversed.

IV. CONCLUSION

This paper has presented the fundamental structure and the operating characteristics of the proposed new conveyor system

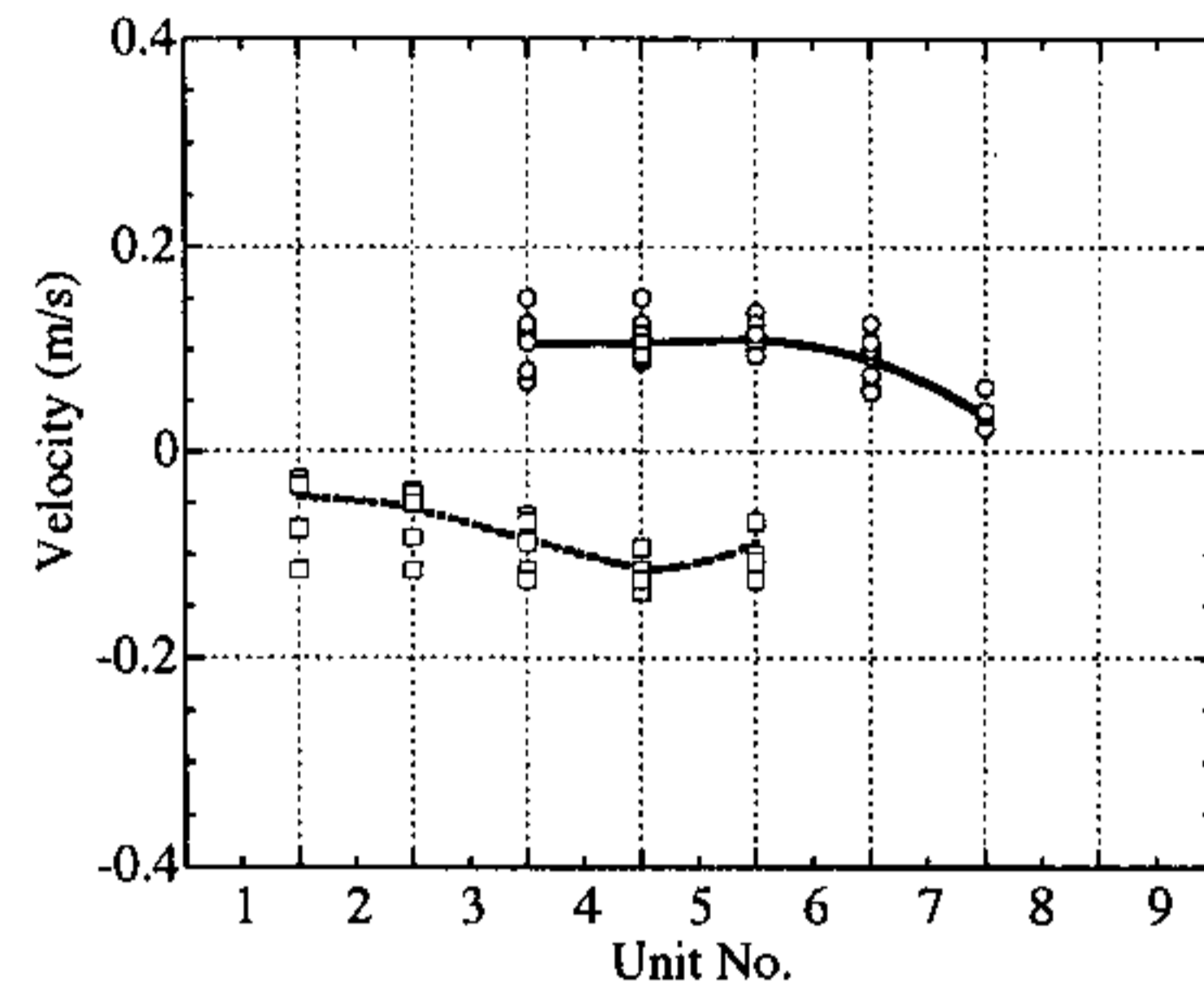

Fig. 9. Conveyance speed test. When a thin sponge sheet was placed on the shafts, it moved by the maximum speed of 0.1 m/s .

using repulsive-type magnetic bearings. The passive magnetic levitation unit having both soft stiffness and easy rotation generates the conveyance force due to the ellipse oscillation by two electromagnets. On phase reversal at regular interval, the conveyor composed of several units will execute forward and backward movement with the light object on it.

REFERENCES

- [1] J. P. Yonnet, "Permanent magnets bearings and couplings," *IEEE Trans. Magn.*, vol. MAG-17, pp. 740–741, Jan. 1981.
- [2] —, "Analytical calculations of magnetic bearings," in *Proc. 5th Rare-Earth Cobalt Magnet Workshop*, Roanoke, VA, June 1981, pp. 199–216.
- [3] T. Ohji, S. C. Mukhopadhyay, M. Iwahara, and S. Yamada, "Permanent magnet bearings for horizontal- and vertical-shaft machines—a comparative study," *J. Appl. Phys.*, vol. 85, no. 8, pp. 4648–4650, Apr. 1999.
- [4] S. C. Mukhopadhyay, T. Ohji, M. Iwahara, and S. Yamada, "Modeling and control of a new horizontal shaft hybrid type magnetic bearing," *IEEE Trans. Ind. Electron.*, vol. 47, no. 1, pp. 100–108, Feb. 2000.
- [5] I. Satoh, Y. Shirao, and Y. Kanemitsu, "Dynamics and vibration of a single axis active magnetic bearing system for small-sized rotating machinery," in *Proc. 5th Int. Symp. Magnetic Bearings*, Kanazawa, Japan, Aug. 1996, pp. 497–502.
- [6] T. Ohji, S. Ikeno, K. Amei, M. Sakui, and S. Yamada, "Development of a polygon scanner motor using single-axis controlled repulsive type magnetic bearing system," in *Proc. 11th Int. Symp. Applied Electromagnetics and Mechanics*, Versailles, France, Mar. 2003, pp. 319–320.
- [7] T. Ohji, T. Azuma, S. Yamada, and M. Iwahara, "Proposed configuration of the repulsive type thermo balance magnetic levitation system using permanent magnets," in *Proc. Int. Symp. Linear Drives for Industry Applications*, Nagano, Japan, Oct. 2001, pp. 360–364.