

A Numerical Method for Analyzing a Passive Fault Current Limiter Considering Hysteresis

メタデータ	言語: eng 出版者: 公開日: 2017-10-03 キーワード (Ja): キーワード (En): 作成者: メールアドレス: 所属:
URL	http://hdl.handle.net/2297/48297

A Numerical Method for Analyzing a Passive Fault Current Limiter Considering Hysteresis

A. Mukherjee, S.C. Mukhopadhyay, M. Iwahara, S. Yamada
Kanazawa University, Kanazawa, Japan

F.P Dawson

Dept. of Electrical Engineering, University of Toronto, Canada

Abstract - Fast transient analysis of a passive fault current limiter (FCL) using permanent magnets can be done by direct numerical solution of a single non-linear differential equation. The non-linear $B-H$ excursion that is caused by hysteresis is incorporated in the computation using a transient hysteresis model. Rational fractions are used to represent the parent hysteresis loop curves. Since the method uses preconstructed expressions as applicable to FCL schemes only, computation time required is less.

Index Terms - Electromagnetic Transients, FCL, Hysteresis Model, Rational Fraction, Runge-Kutta

I. INTRODUCTION

Non-linear analysis of the electromagnetic transient phenomena in a passive fault current limiter (FCL) has so far been based on a generalized solution technique named the Tableau method [1]. While applying this method the reported works so far adopted single line nonlinearity to represent the $B-H$ characteristics of the FCL cores [2]. This paper presents a numerical method incorporating a simple transient hysteresis model as offered by Talukdar and Bailey [3], to assess the transient, tracing the $B-H$ excursion as happens due to hysteresis phenomena. Since the method utilizes mathematical expressions deduced beforehand for FCL application schemes, the computation time is short. The analytical method presented here, solves a single differential equation governing the transient in the circuit, by the 4th order Runge-Kutta method. For the application of the hysteresis model, the biggest possible (parent) loop is represented by rational fractions [4].

II. FORMATION OF TRANSIENT EQUATION

In Fig.1 $E_0(t)$ is the sinusoidal source and Z_S is the source impedance. $-e_1(t)$ and $-e_2(t)$ are the e.m.f. induced in the two FCL cores due to flux variation and Z_L is the load impedance. If we consider equivalent impedance in series with the FCL, $Z = Z_S + Z_L$, then the following equation can be formed for the loop [5]:

$$E_0(t) - i(t) \cdot Z = e_1(t) + e_2(t) \\ = N \frac{d\phi_1}{dt} + N \frac{d\phi_2}{dt}$$

Manuscript received October 15, 1997

A.Mukherjee, + 81- 76 - 234 - 4943,

fax : + 81 - 76 - 234 - 4946,

abhijit@magstar.ec.t.kanazawa-u.ac.jp

[where ϕ_1 and ϕ_2 are fluxes in the two cores]

$$= NA \left[\frac{dB_1}{dH_1} \frac{dH_1}{dt} + \frac{dB_2}{dH_2} \frac{dH_2}{dt} \right] \cdot \frac{di}{dt} \quad (1)$$

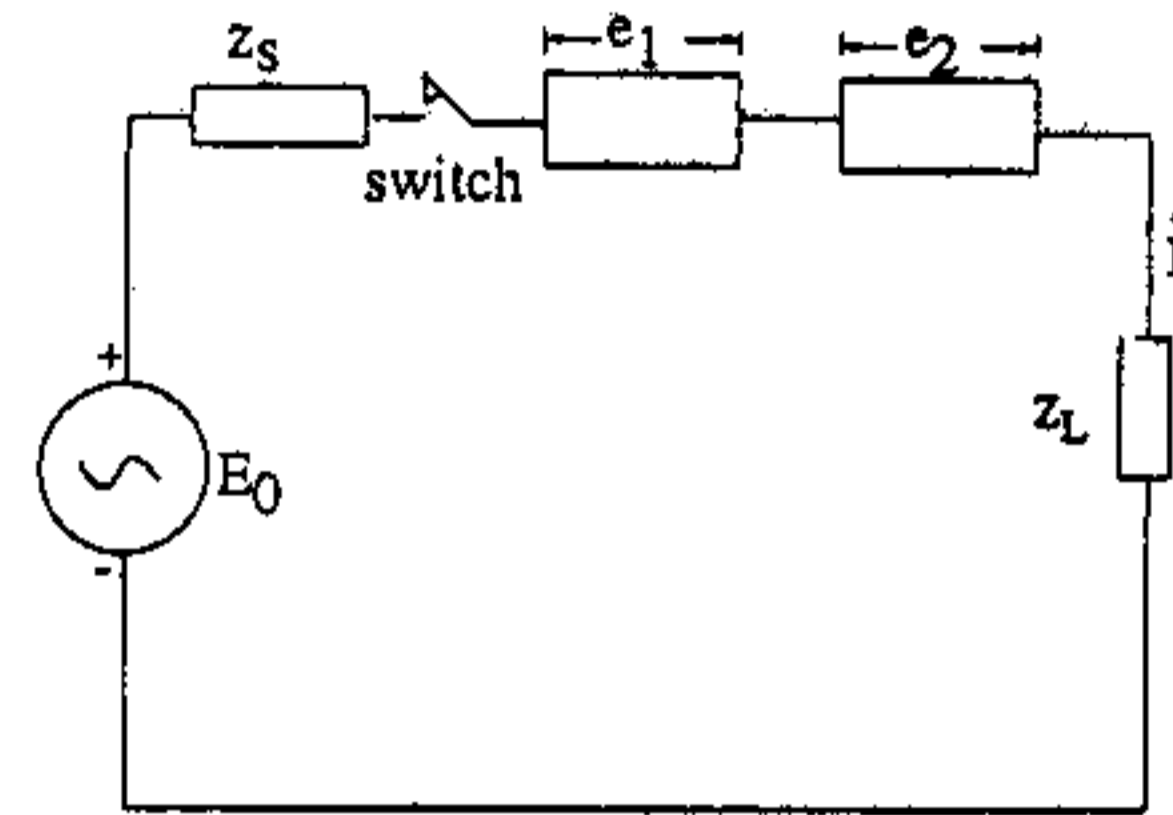

Fig.1 Schematic representation of FCL application

As shown in Fig.2, in an FCL core, if we summed all the m.m.f. sources and magnetic potential drops with proper algebraic sign, then [6],

$$N \cdot i(t) + H_{CO} \cdot l_m - H \cdot l - R_m \cdot \phi = 0 \quad (2)$$

where,

l_m = length of the permanent magnet

l = length of the ferrite core

H = magnetic field intensity in the core

R_m = Reluctance within the permanent magnet

H_{CO} = Coercivity of the permanent magnet material

ϕ = flux, considered to be same through the permanent magnet and the core.

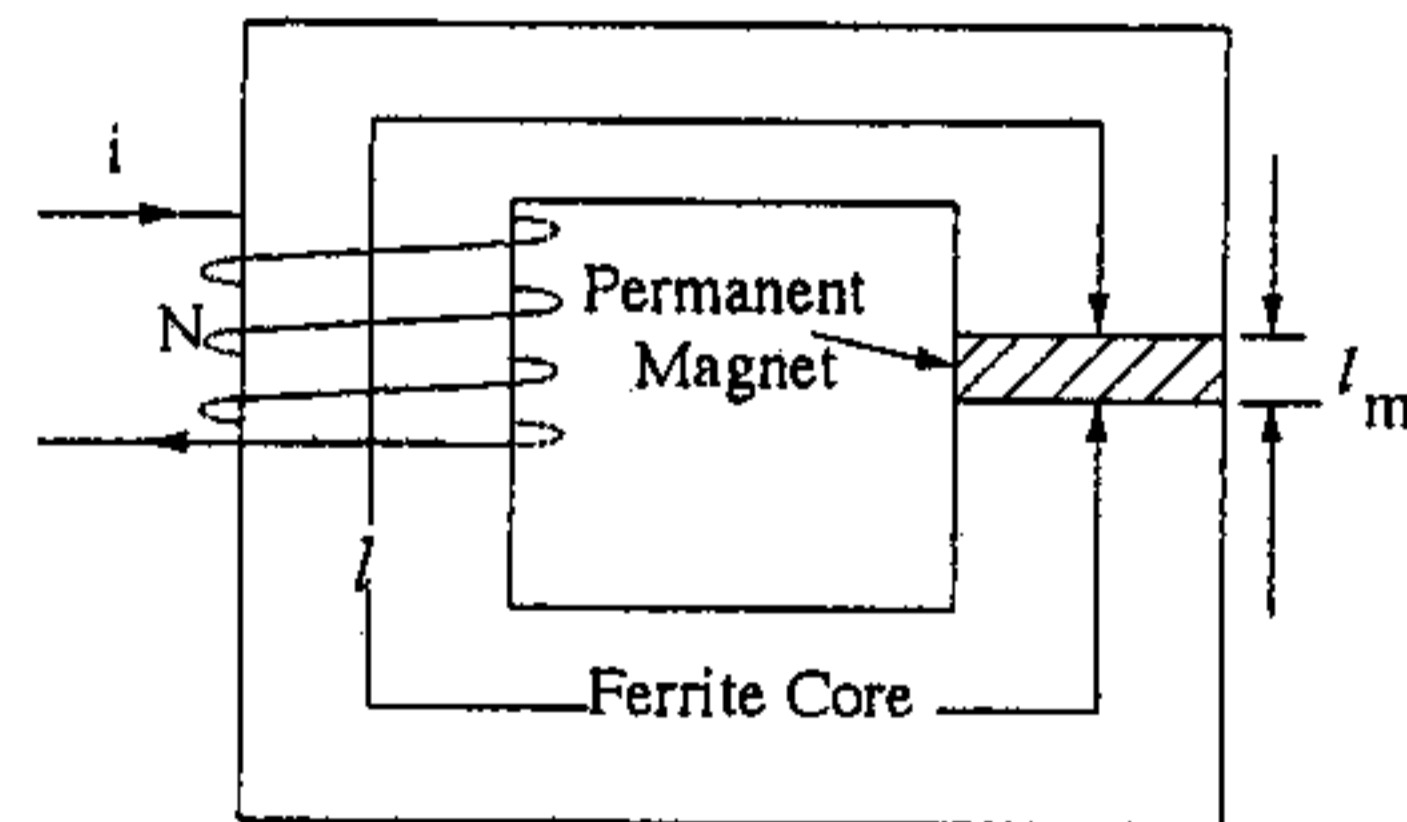

Fig.2 The core of FCL with inserted permanent magnet

Differentiating (2) with respect to i we get,

$$\frac{dH}{di} = \frac{N}{l + R_m A \frac{dB}{dH}} \quad (3)$$

Putting this in (1) we obtain,

$$\frac{di}{dt} = \frac{E_0 - i \cdot Z}{NA \left[\frac{dB_1}{dH_1} \left(l + R_m A \frac{dB_1}{dH_1} \right) + \frac{dB_2}{dH_2} \left(l + R_m A \frac{dB_2}{dH_2} \right) \right]} \quad (4)$$

If for any $i(t)$ value H can be found and for any H value dB/dH can be calculated then (4) can be easily solved using 4th order Runge-Kutta method. Hence we have to choose a hysteresis model wherein for any H value during transient $B-H$ excursion dB/dH can be easily computed.

III. HYSTERESIS MODEL

Fig.3 shows a parent or biggest possible hysteresis loop to be represented by rational fractions and another member of the family of upgoing $B-H$ curves within the loop. We call the upgoing curve on the parent loop, function f_2 and the down going one, function f_1 . Let the gap between the two upgoing curves be d_T at the turn-around point X . Studying several families of upgoing and downgoing curves this model assumes that the gap d corresponding to any flux density value B on the inner curve, is a linear function of B .

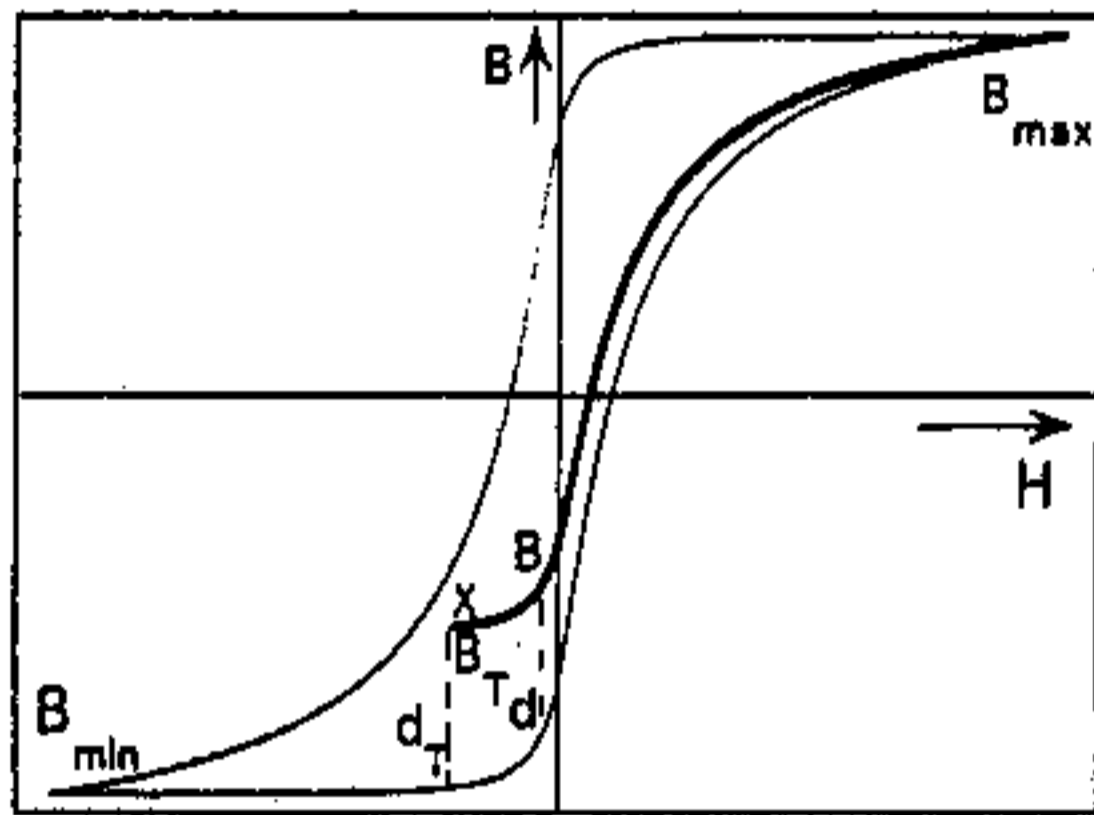

Fig.3 Parent Loop and inner curve

$$\text{Thus, } \frac{B - f_2(H)}{d_T} = \frac{B_{\max} - B}{B_{\max} - B_T} \tag{5}$$

By differentiating the above equation with respect to H and then simplifying,

$$\frac{dB}{dH} = \frac{B_{\max} - B_T}{B_{\max} - B_T + d_T} \cdot \frac{df_2}{dH} \tag{6}$$

for a downgoing curve,

$$\frac{dB}{dH} = \frac{B_T - B_{\min}}{B_T - B_{\min} + d_T} \cdot \frac{df_1}{dH} \tag{7}$$

In an iterative numerical method B_T, d_T are quantities of the previous instant and are known.

IV. RATIONAL FRACTIONS FOR PARENT LOOP

Fig.4 shows a typical non-linear behaviour of a $B-H$ loop where f_1 and f_2 are the descending and ascending curves respectively. From these curves, auxiliary curves Y_1 and Y_2 are obtained [4].

Making pertinent assumptions about the symmetry of the auxiliary curves and supposing a second degree approximation, we have,

$$Y_1 = \mu_0 \left[H + \frac{a_1 H + a_2 H \cdot |H|}{1 + b_1 |H| + b_2 H^2} \right] \tag{8}$$

$$Y_2 = \mu_0 \left[\frac{c_1 (H_m - |H|) + c_2 (H_m^2 - H^2)}{1 + b_1 |H| + b_2 H^2} \right] \tag{9}$$

where a_1, a_2, b_1, b_2, c_1 and c_2 are the coefficients of the rational fractions. H_m is the maximum field strength corresponding to B_{\max} .

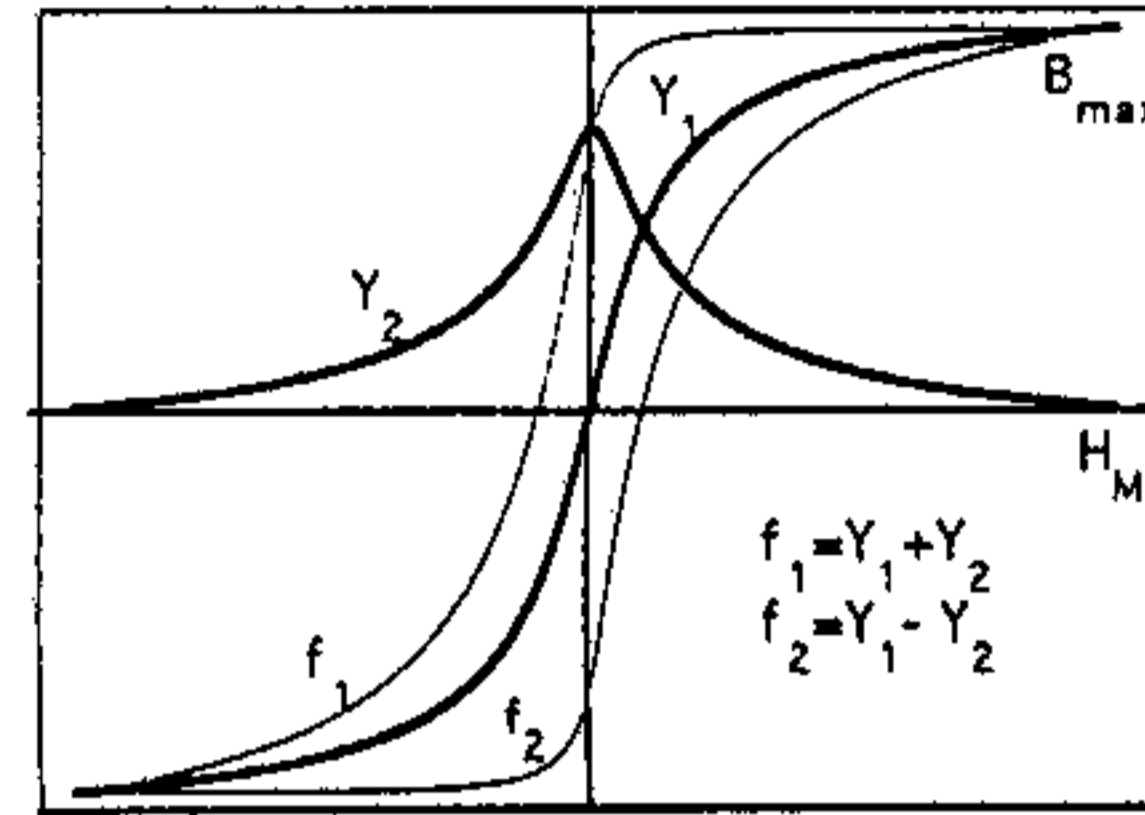

Fig.4 Symmetrical Hysteresis Loops with Auxiliary Curves

$$\text{Now, } \frac{dY_1}{dH} = \mu_0 \left[1 + \frac{a_1 + 2a_2 |H| + (a_2 b_1 - a_1 b_2) H^2}{(1 + b_1 |H| + b_2 H^2)^2} \right] \tag{10}$$

$$\text{and } \frac{dY_2}{dH} = \frac{\mu_0 \cdot A(H)}{(1 + b_1 |H| + b_2 H^2)^2} \tag{11}$$

$$\text{where, } A(H) = -c_1 \frac{|H|}{H} - 2c_2 H - c_2 b_1 H |H| - c_1 b_1 H_m \frac{|H|}{H} + c_1 b_2 H |H| - 2c_1 b_2 H_m H - c_2 b_1 H_m^2 \frac{|H|}{H} - 2c_2 b_2 H_m^2 H$$

Putting these expressions in (6) and (7), as the case may be, we can easily find dB/dH for any H value and thus what remains is to find the H inside the core for any current i .

V. FINDING H FOR i

From (2), if we plot ϕ vs H for different values of current i , they will be a family of straight lines, since,

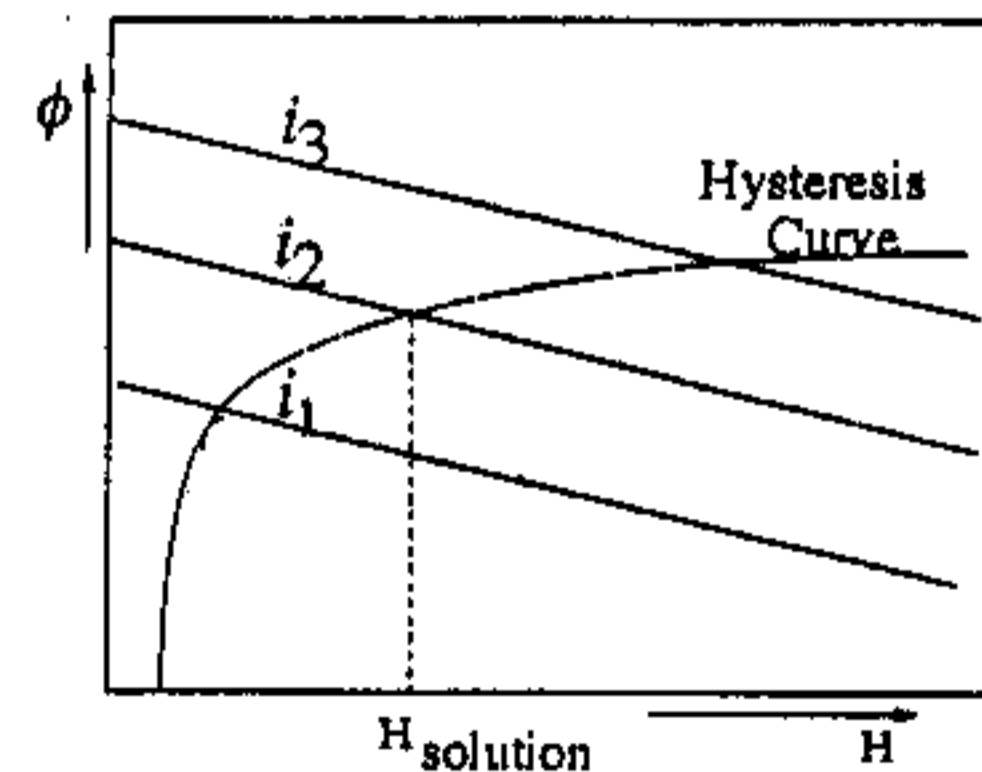

Fig.5 Determination of field intensity for current value

$$\phi = \frac{N \cdot i + H_{CO} \cdot l_m - H \cdot l}{R_m} \tag{12}$$

Again, if we plot flux following the hysteresis model against field intensity, a non-linear curve will result for a particular starting point flux density. Thus the intersection point of these two plots gives the H for a certain current value as in Fig.5.

Numerical solution for H can be very easily obtained by iterative scanning of the functions and if necessary by adopting straight line approximation without much effect on the accuracy, since over a very short duration between two successive instants any variation can be safely taken to be linear.

VI. SELECTION CRITERION FOR UPGOING /DOWNGOING CURVE

One of the requirements for transition from single line non-linearity model to a full fledged hysteresis model is that, since the upgoing and downgoing functions are not same for a hysteresis model, a clear foolproof criterion must be there for deciding whether the solution should be attempted on an upgoing $B-H$ curve or a decreasing one. The method followed in this work are as below:

We know,

$$e = NA \frac{dB}{dt}$$

Using trapezoidal rule of integration and indicating the time instant within parenthesis,

$$e(t) = -e(t - \Delta t) + \frac{2NA}{\Delta t} [B(t) - B(t - \Delta t)] \tag{13}$$

Now say,

$$E(t) = E_0(t) - Z \cdot i(t) = e_1(t) + e_2(t) \tag{14}$$

If the current and thus the flux densities remain unchanged over successive time steps i.e. $B(t) = B(t - \Delta t)$, then from (13) we get,

$$E(t) = -[e_1(t) + e_2(t)] = -E(t - \Delta t) \tag{15}$$

$$\text{Also, } E(t) = E_0(t) - Z \cdot i(t) \tag{16}$$

Now, if $E(t)$ obtained from (16) is greater than that obtained from (15), the current and hence flux densities have to increase. On the other hand, a downgoing curve is warranted if (16) yields a lesser $E(t)$ than yielded by (15).

VII. A CASE STUDY

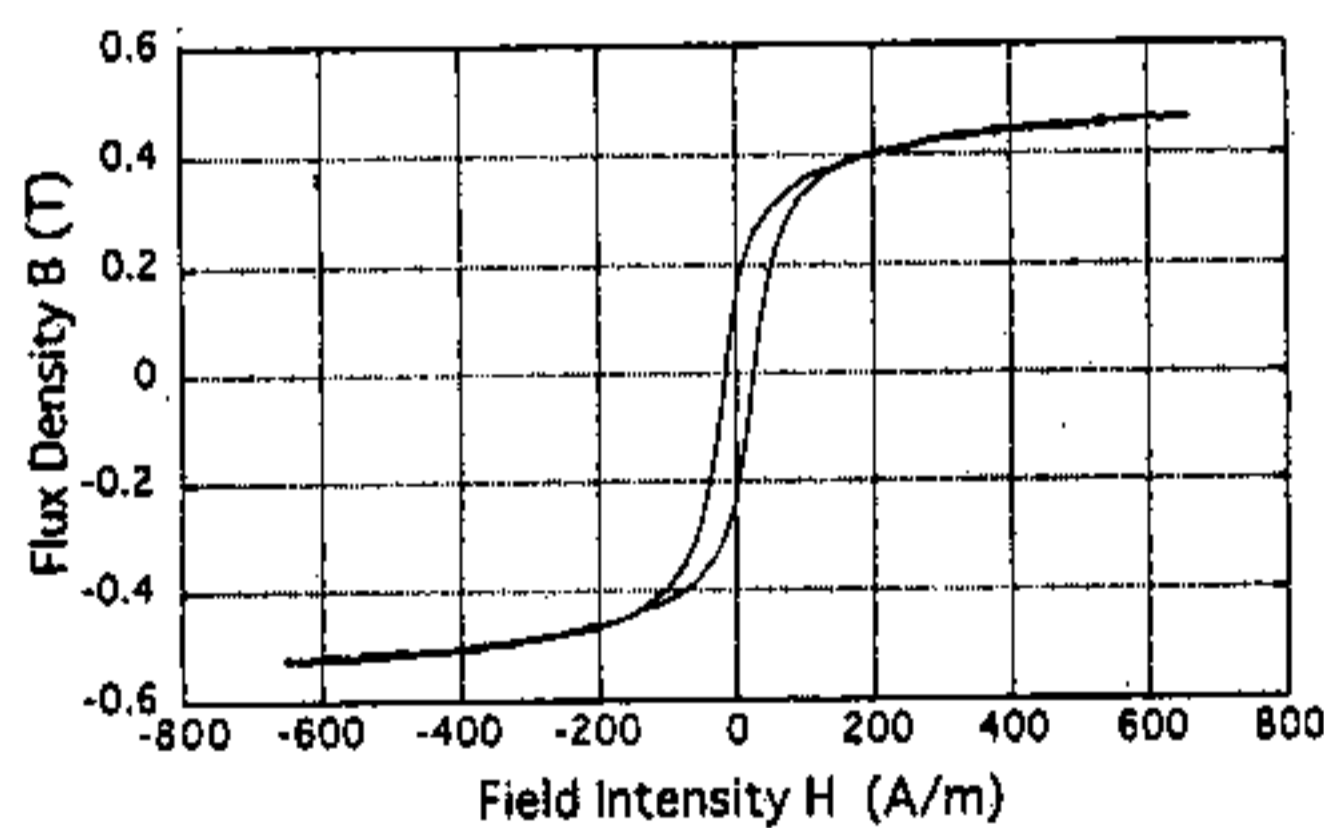

Fig.6 The hysteresis loop for ferrite core

As a case study an FCL scheme is taken up with the following details:

- Core length = 74.5 mm
- Area of the core = 118.5 mm²
- Length of Permanent Magnet = 0.1 cm
- No. of Turns in each unit = 150

Fig.6 shows the hysteresis loop for the ferrite core.

The circuit impedance changes from 10 ohms to 1 ohm during fault and Fig.7 shows the current and voltages before and after fault, as obtained by simulation. Fig. 8 gives the experimental result for the same scheme.

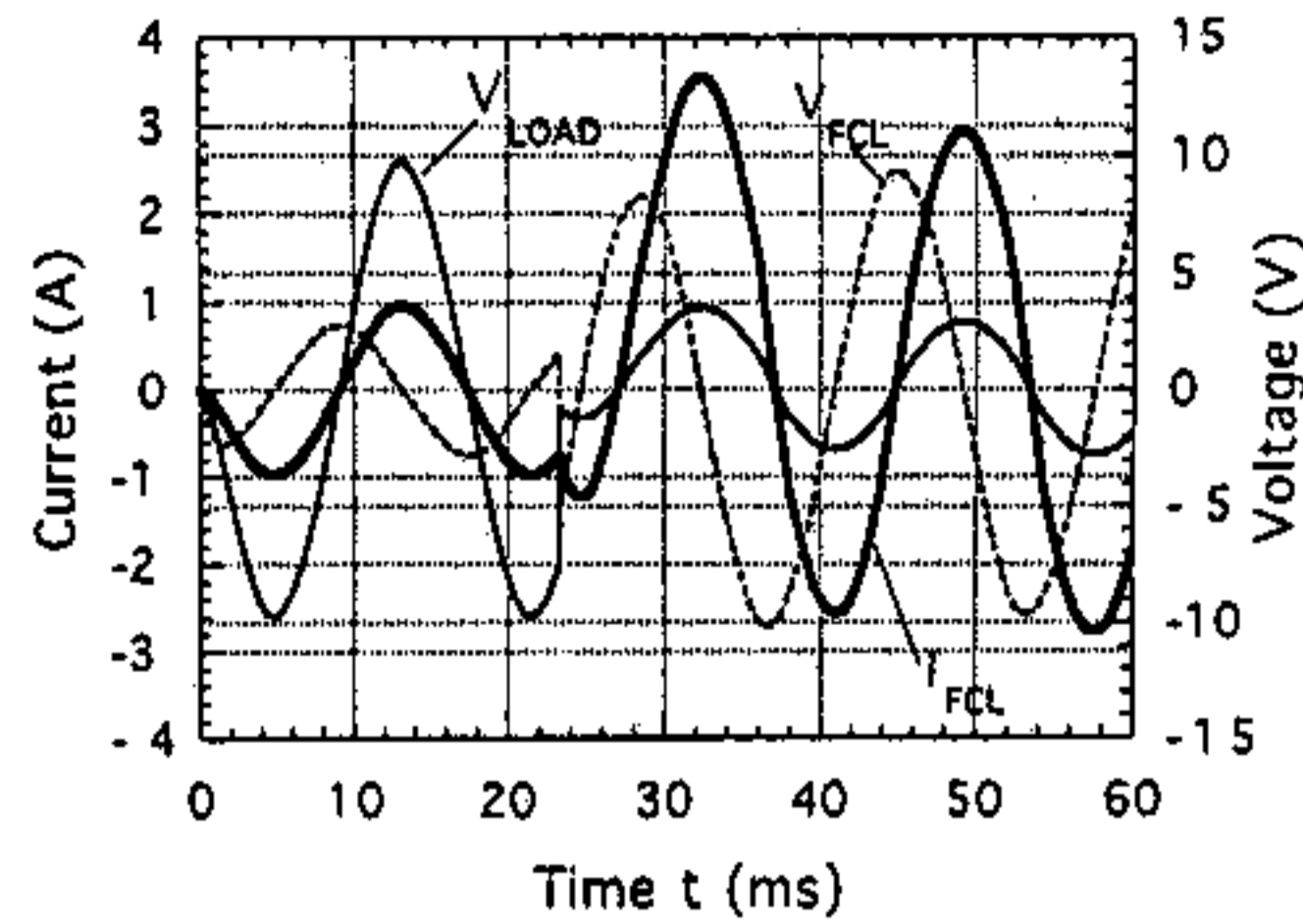

Fig.7 Current through and voltages across FCL and series impedance

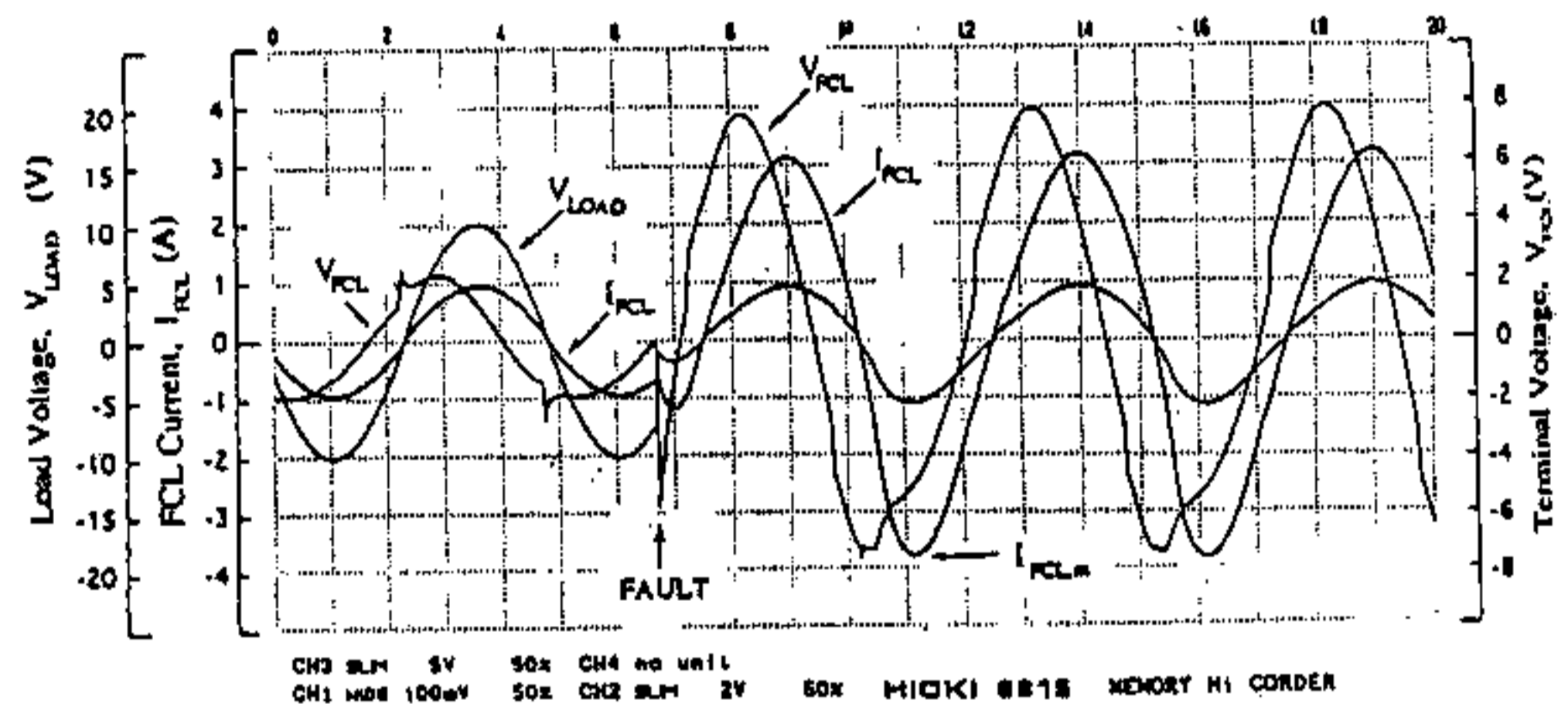

Fig. 8 The experimental result

VIII. CONCLUSION

This method is simple and can accommodate any change in the FCL configuration. The CPU time required to compute FCL performance spanning 4 power frequency cycles has been 15 seconds in a 90 MHz clock-speed Pentium machine against 56 seconds taken by conventional method.

REFERENCES

- [1] M. Iwahara and E. Miyazawa, " A Numerical Method for Calculation of Electromagnetic Circuits Using the Tableau Approach " IEEE Trans. Magnetics, vol. MAG-19, No.6, November 1983, pp 2457-2460.
- [2] S.C.Mukhopadhyay, M. Iwahara, S. Yamada and F.P.Dawson," Consideration of Operation of Passive Fault Current Limiter Including Eddy Current by Means of Tableau Approach", National Convention of the Institution of Electrical Engineers, Japan, March 1997, pp 2-336 - 2-227.
- [3] S. N. Talukdar and J.R.Bailey, " Hysteresis Models for System Studies", IEEE Trans. Power App. & Sys. PAS-95, No.4, pp 1429-1434, July / Aug. 1976.
- [4] J.Rivas, J.M.Zamarro and E. Martin, " Simple Approximation for Magnetization " IEEE Trans. Magnetics, vol. MAG-17, No.4, July 1981, pp 1498-1502.
- [5] H.W. Dommel, " Non-linear and Time Varying Elements in Digital Simulation of Electromagnetic Transients ", IEEE Trans. Power App. & Sys. PAS-90, Nov./Dec. 1971, p 2561.
- [6] S. Young, F.P.Dawson, A. Conrad, "Modeling of a Passive di/dt Limiter" IEEE Trans. on Magnetics, vol.8, No.5, September 1992, pp 3051-3053.