

A Novel Compact Magnetic Current Limiter for Three Phase Applications

メタデータ	言語: eng 出版者: 公開日: 2017-10-03 キーワード (Ja): キーワード (En): 作成者: メールアドレス: 所属:
URL	http://hdl.handle.net/2297/48326

A Novel Compact Magnetic Current Limiter for Three Phase Applications

S. C. Mukhopadhyay, *Member, IEEE*, F. P. Dawson, *Member, IEEE*, M. Iwahara, *Member, IEEE*, and S. Yamada, *Member, IEEE*

Abstract—The fabrication and development of a novel compact three phase magnetic current limiter consisting of permanent magnets (PM) and saturable cores is described in this paper. Simulation results using the tableau approach are presented for varying operating conditions. Experimental results are in good agreement with the simulation results. The proposed current limiter has potential in moderately low voltage applications.

Index Terms—Magnetic current limiter, permanent magnet, saturable core, tableau method, three-phase.

I. INTRODUCTION

THE DESIGN and development of a single-phase magnetic fault current limiter (FCL) consisting of a permanent magnet and saturable core has been reported recently [1], [2]. The development of this approach has been motivated by the concerns over the economics, efficiency or reliability of existing fault current limiters that are based on superconductors or active components such as power semiconductor or vacuum switches [3]. The existing current limiter configuration can be extended to three phase applications by utilizing three separate single-phase units. This type of scheme is complicated and expensive to construct.

This paper presents a novel compact three-phase magnetic fault current limiter consisting of two devices connected in series. Each device consists of one permanent magnet, three saturable cores and three windings. The ac mmfs in the two devices are in counter opposition to each other. The permanent magnet can be configured in either a parallel or series biasing mode. A series biasing scheme is used in our implementation.

A NdFeB magnet with axial magnetization is used to bias the cores. The saturable core can be constructed of a ferrite or steel material [2] or any other material having a low saturated flux density and a low saturated permeability. Each of the three core and winding assemblies are placed at an angle of 120° with respect to each other. The combination of two such assemblies, as shown in Fig. 1, results in a bipolar fault current limiter.

The permanent magnet biases all three cores into saturation under normal operating conditions (i.e., at low values of current) and thus the inductance of each winding is low. The fault current limiter is placed in series with the load and has a very low voltage drop across it under normal operating conditions. Under

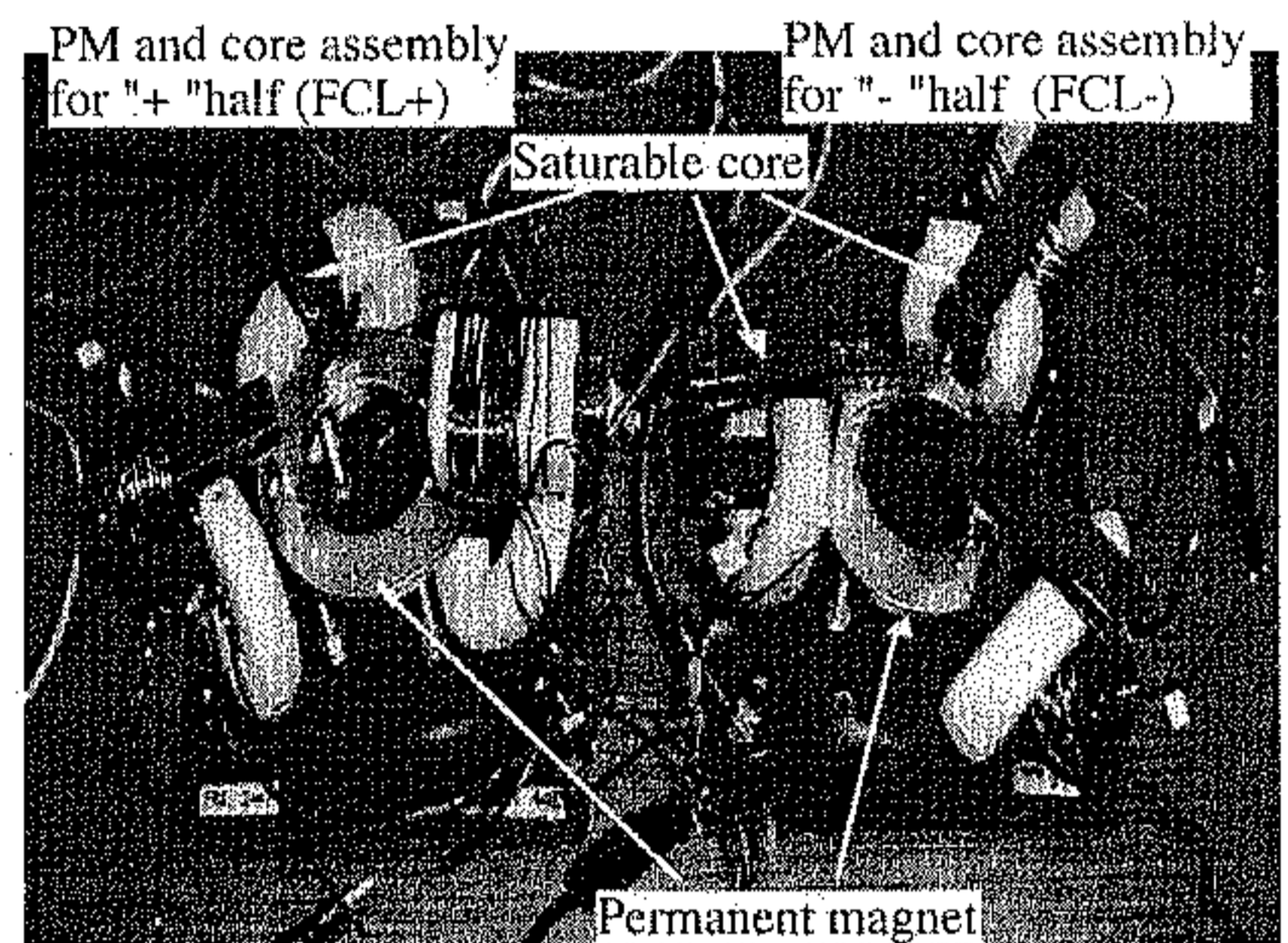

Fig. 1. Picture of the fabricated model.

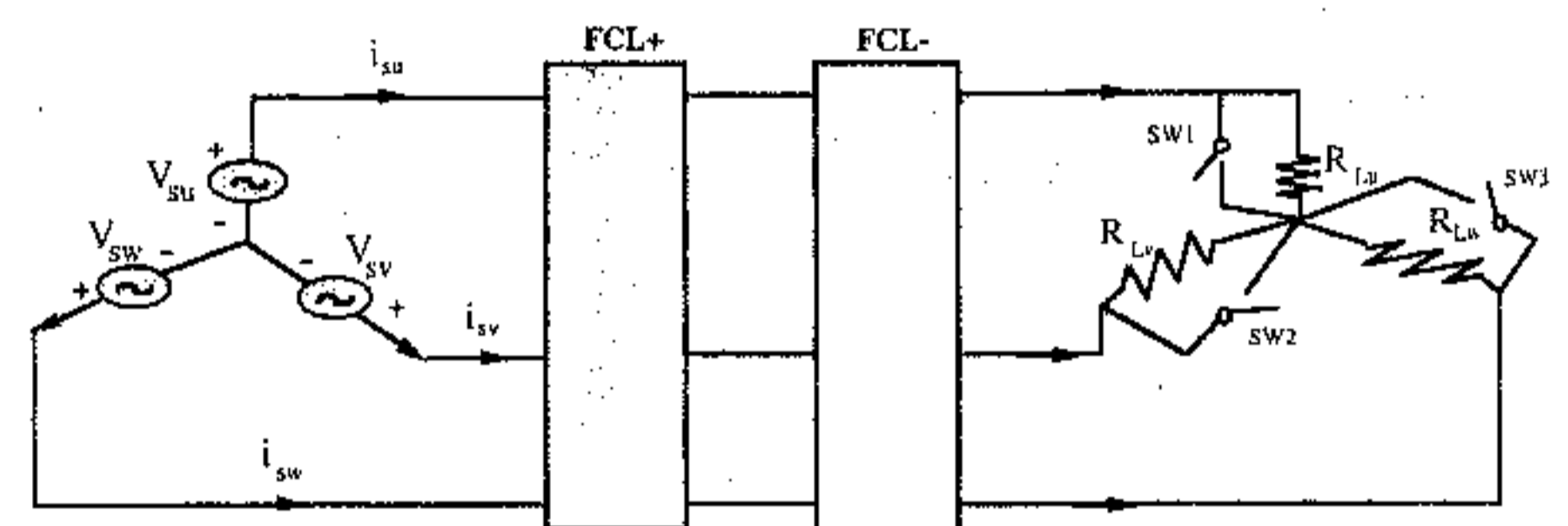

Fig. 2. Experimental circuit for performance evaluation.

fault conditions, the supply voltage appears across the fault current limiter, resulting in a limit on the value of the fault current.

II. ANALYSIS AND SIMULATION RESULTS

Fig. 2 shows the circuit used for the analysis. The Tableau method was used to characterize the circuit as a combination of electric and magnetic circuits as shown in Fig. 3 [4]. The magnetic circuit includes the mmf of the PM and the reluctances of the PM and the core. Here “ m ” denotes the magnet and “ u ,” “ v ” and “ w ” are the three phases of the supply. “ R_p ” and “ R_m ” denote the magnetic reluctance of the positive half (FCL+) and the negative half (FCL-) of the limiter respectively. “ r_x ,” “ r_p ” and “ r_m ” denote the resistance of the source, FCL+ coil and FCL- coil, respectively. The performance of the current limiter has been simulated for different values of load resistance. The fault is simulated by shunting the load resistances R_{Lu} , R_{Lv} and R_{Lw} using the switches SW1, SW2 and SW3 respectively.

Manuscript received February 10, 2000.

S. C. Mukhopadhyay, M. Iwahara, and S. Yamada are with Kanazawa University, Japan (e-mail: chandra@magstar.ec.t.kanazawa-u.ac.jp).

F. P. Dawson is with the Electrical Engineering Department, University of Toronto, Canada (e-mail: dawson@power.ele.utoronto.ca).

Publisher Item Identifier S 0018-9464(00)07967-X.

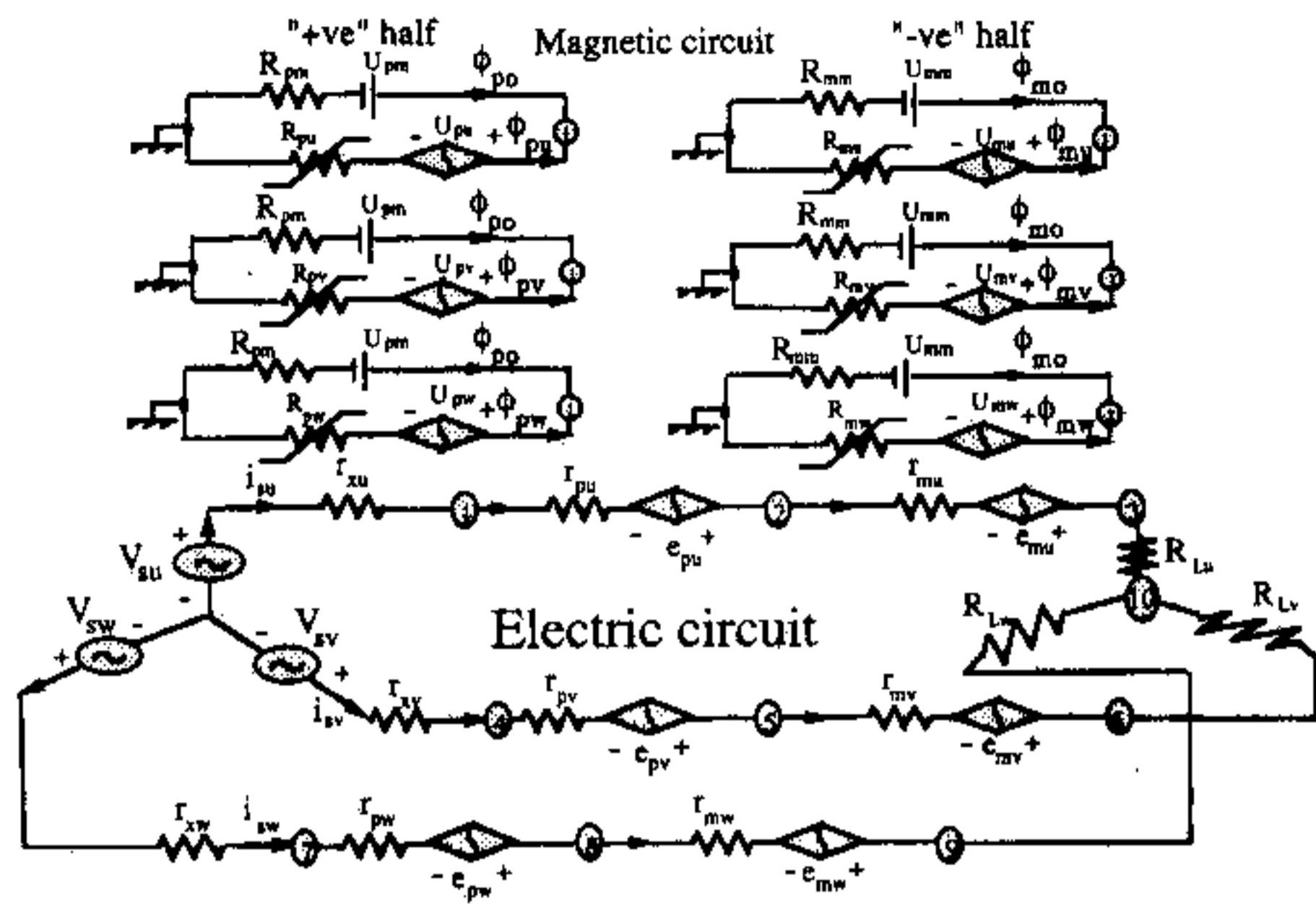

Fig. 3. Electromagnetic equivalent circuit.

TABLE I
DESIGN PARAMETERS OF THE SIMULATED MODEL

Specifications	Voltage = 100 V
	Nominal current = 10A
	Frequency = 60 Hz
	Phase = 3
Permanent magnet	No. of turns = 130
	Area (S_m) = 4800 mm ²
	Length = 5 mm
	$\mu_m = 1.1 \mu_0$
Core	$B_m = 1.1$ T
	$H_c = 0.6 \times 10^6$ A/m
	Area (S_i) = 1200 mm ²
	Length = 150 mm
	$\mu_u = 5000 \mu_0$
	$\mu_s = 10 \mu_0$
	$B_k = 0.4$ T

All the relevant equations for the circuit shown in Fig. 3 can be expressed in a matrix form. The discretized form is shown in (1). The equations are solved using the Gauss-elimination and Newton-Raphson methods.

$$\begin{bmatrix} Z_e & -A_e^t & C_m^t \frac{1}{dt} & 0 & C_m^t \frac{1}{dt} & 0 \\ A_e & 0 & 0 & 0 & 0 & 0 \\ -C_p & 0 & R_{mp} & -A_{mp}^t & 0 & 0 \\ 0 & 0 & A_{mp} & 0 & 0 & 0 \\ -C_m & 0 & 0 & 0 & R_{mm} & -A_{mm}^t \\ 0 & 0 & 0 & 0 & A_{mm} & 0 \end{bmatrix} \begin{bmatrix} i \\ v_c \\ \Phi_p \\ u_{cp} \\ \Phi_m \\ u_{cm} \end{bmatrix} = \begin{bmatrix} v_s \\ 0 \\ U_{cp} \\ 0 \\ U_{cm} \\ 0 \end{bmatrix} \quad (1)$$

The performance of a limiter for a typical system consisting of a 100 V, 3- ϕ , 60 Hz supply and a nominal current of 10 A has been simulated. The design parameters for this model are

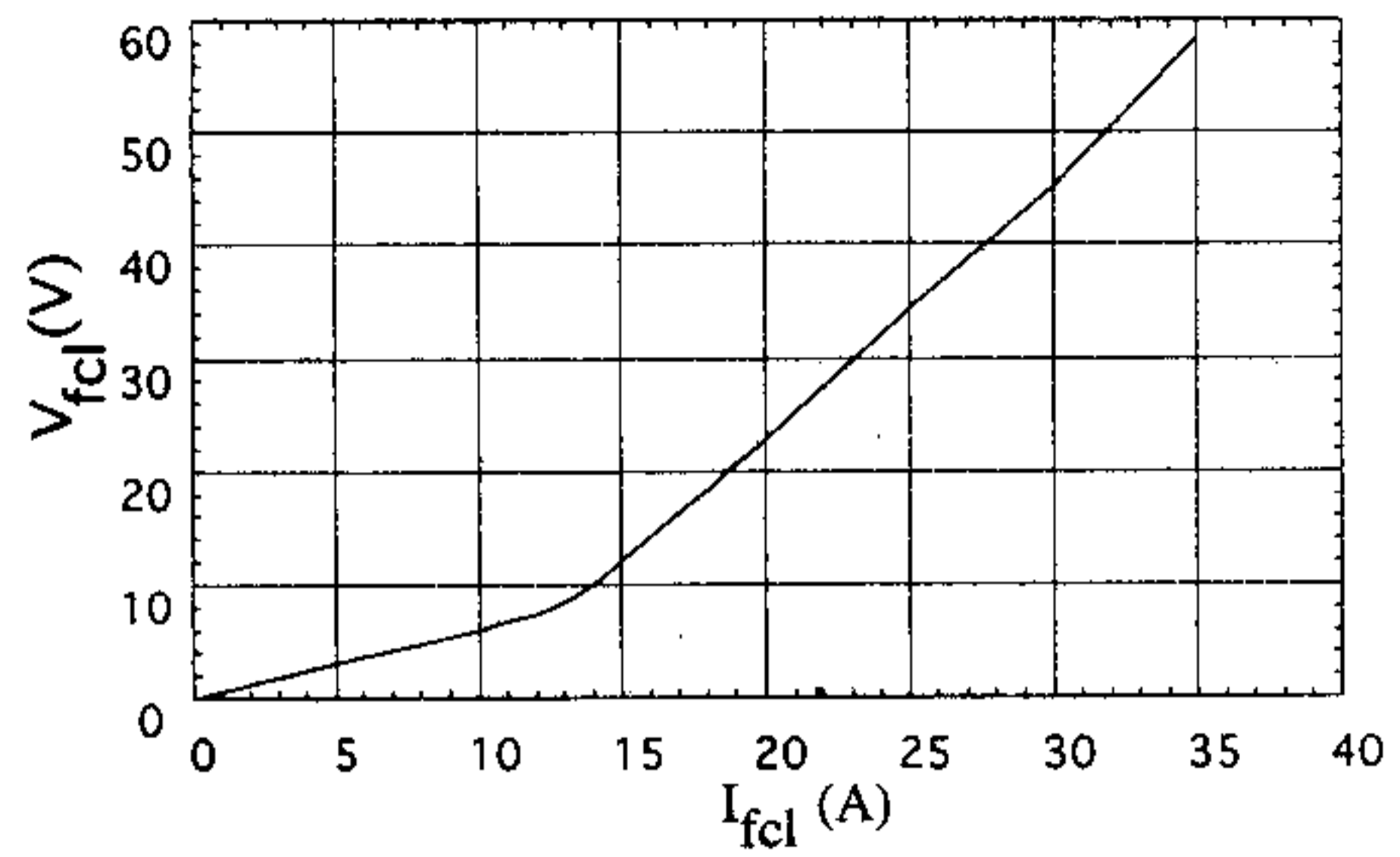

Fig. 4. Simulated $V - I$ characteristics.

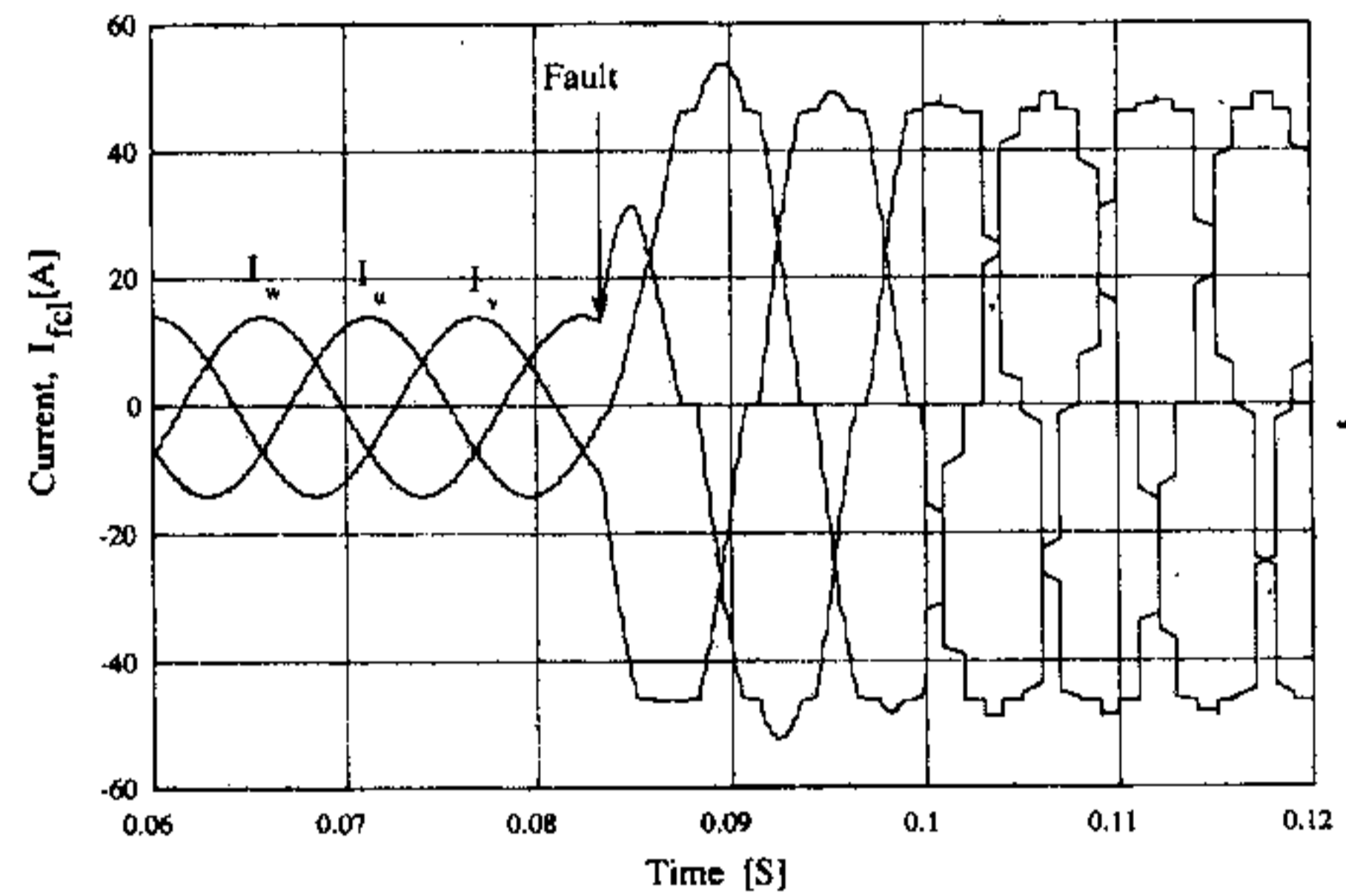

Fig. 5. Current waveforms for a three-phase fault condition.

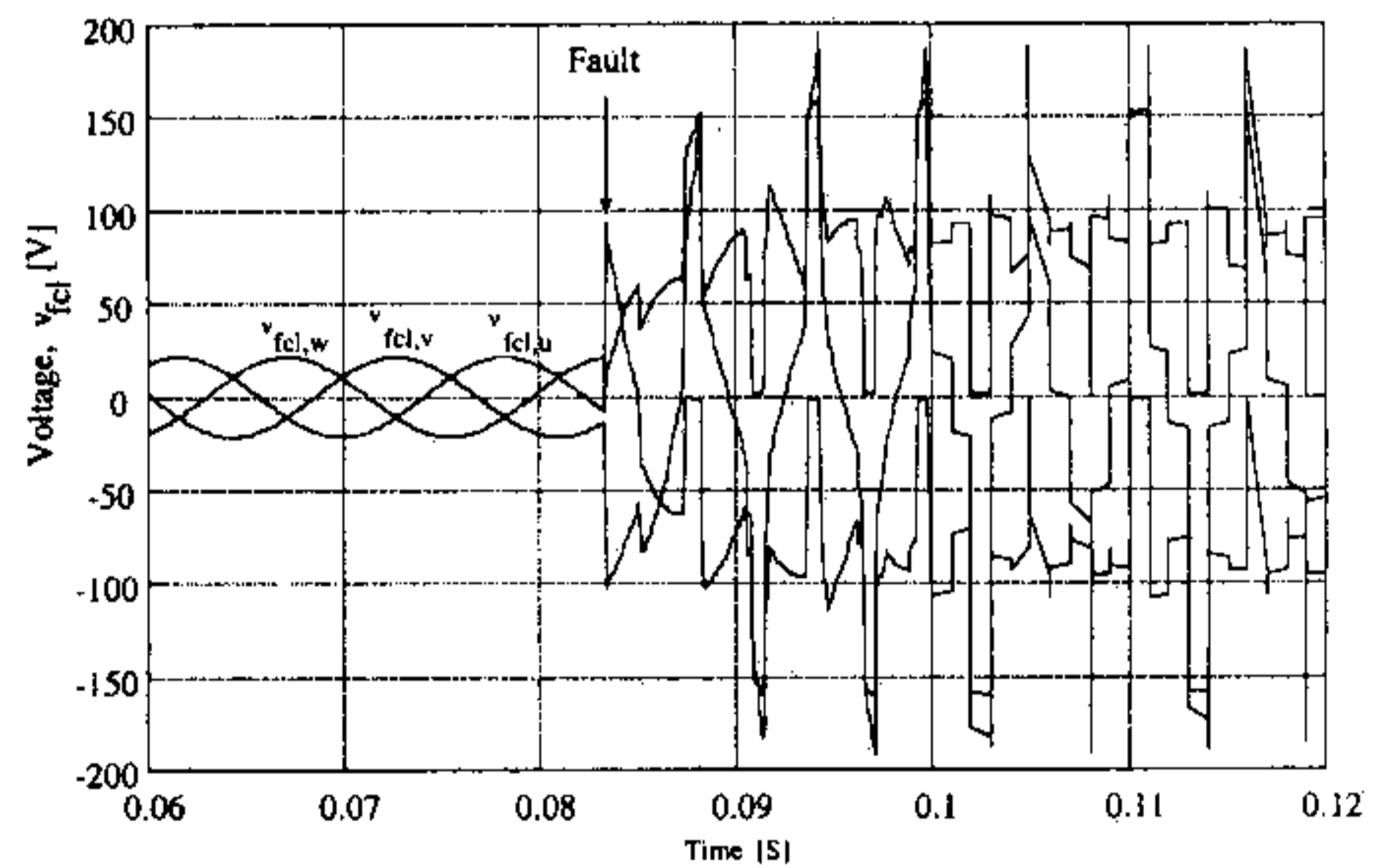

Fig. 6. Voltages across the three phases of the limiter.

listed in Table I. B_m , H_c and μ_m are the remanance, coercivity and the recoil permeability of the PM respectively. B_k is the flux density at the knee point of the core. μ_u and μ_s represent the core's magnetic permeability for the unsaturated state and saturated state respectively.

Fig. 4 shows the variation of rms voltage across one phase of the limiter as a function of rms current through it. It is seen that the slope changes when the current exceeds 10A. Figs. 5 and 6 show the current waveforms and the voltages across the three phases of the limiter for a typical fault condition. The distortion of the waveforms after the fault is due to the swing of operating flux density of the core from the saturated state to the

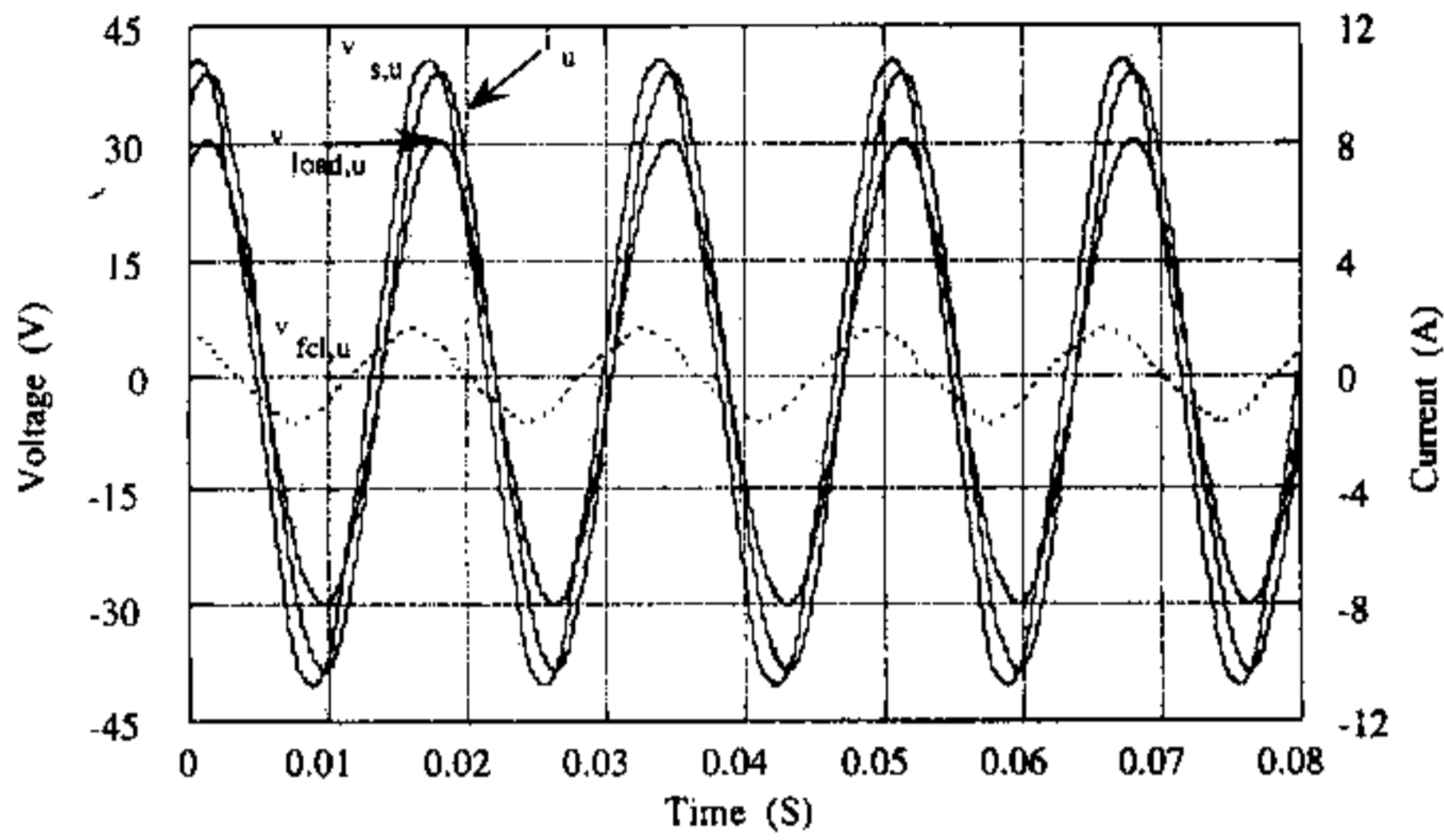

Fig. 7. Transient waveforms at normal operation.

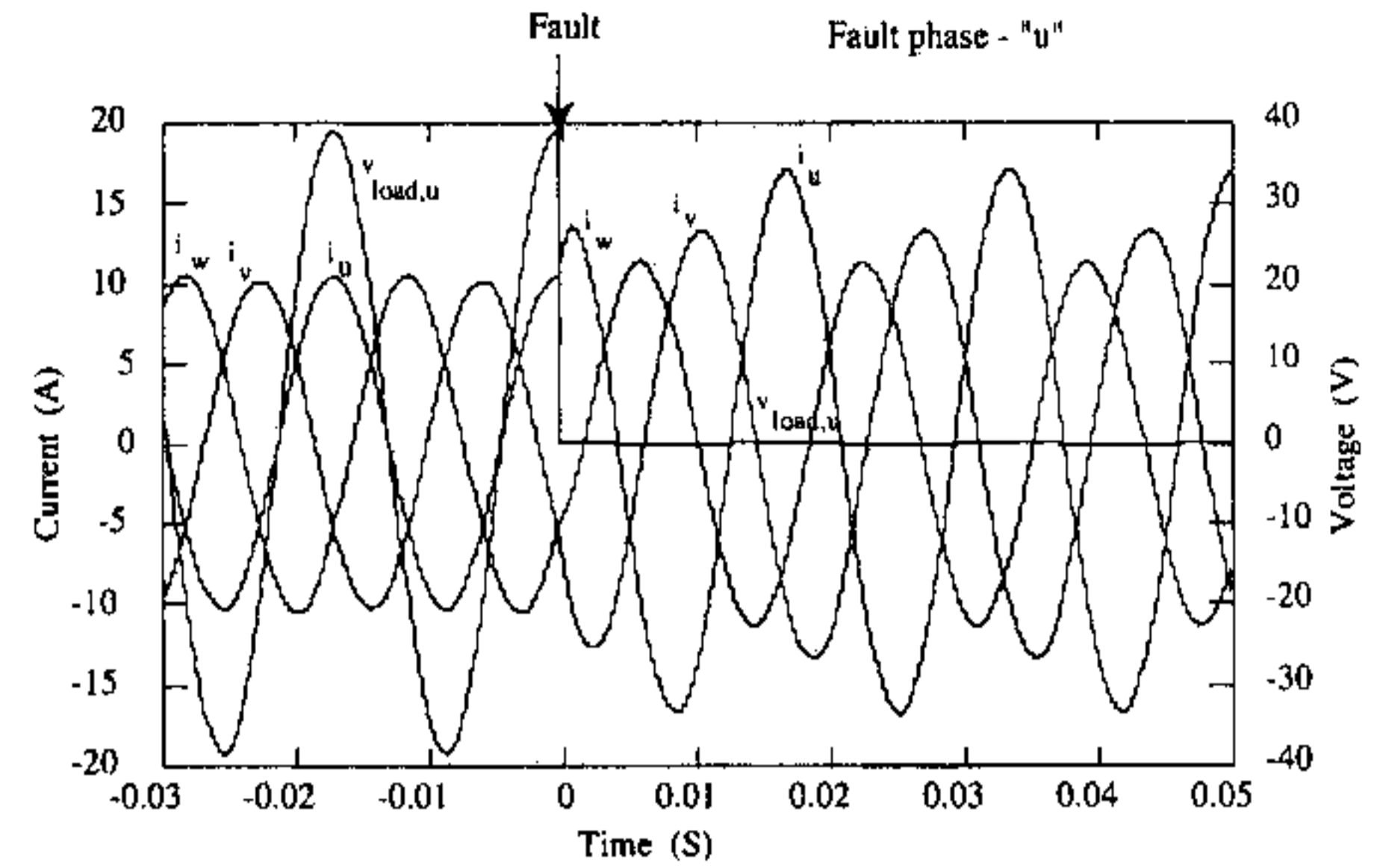

Fig. 9. Transient waveforms at single phase fault condition.

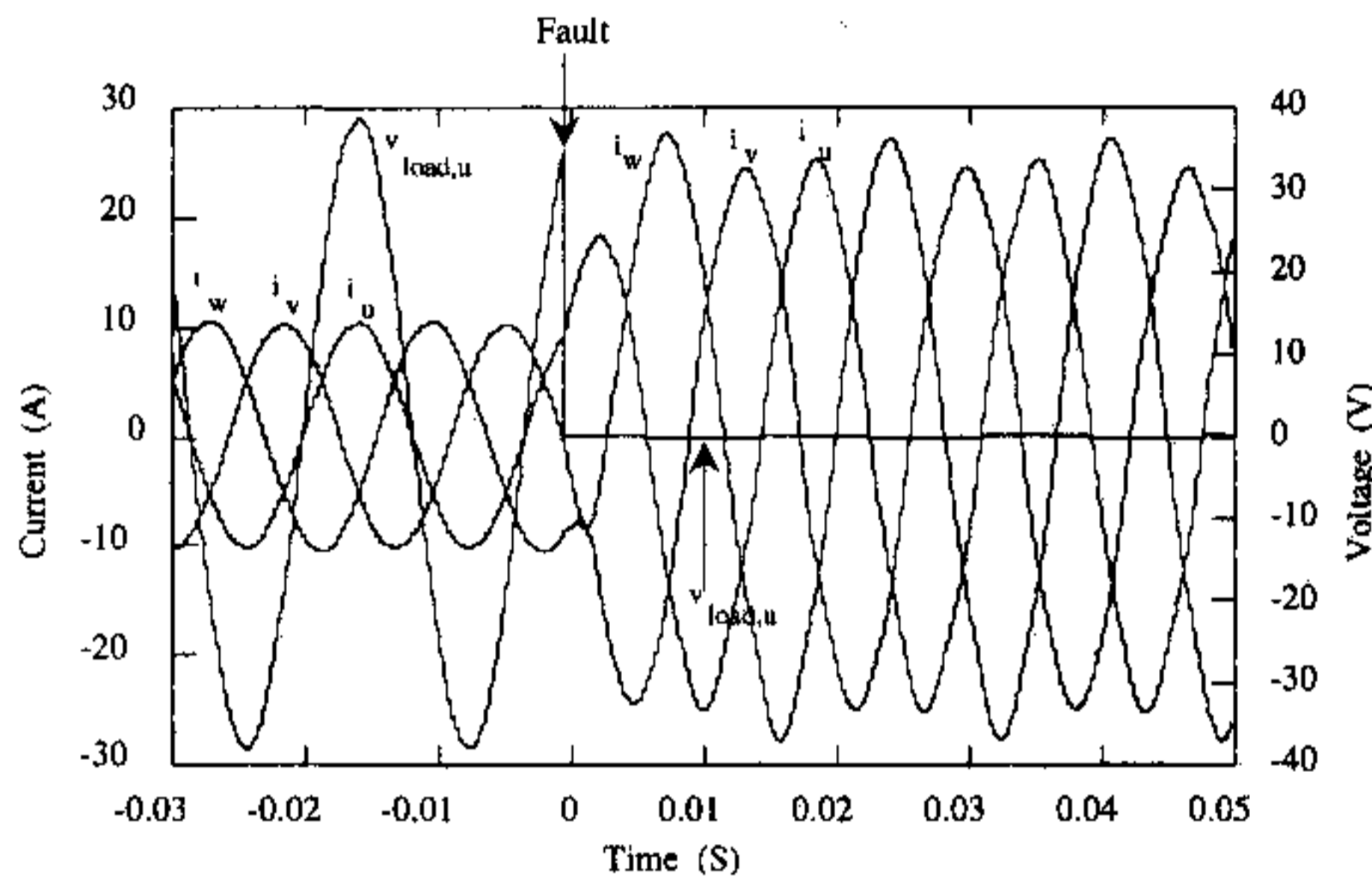

Fig. 8. Transient waveforms at three phase fault condition.

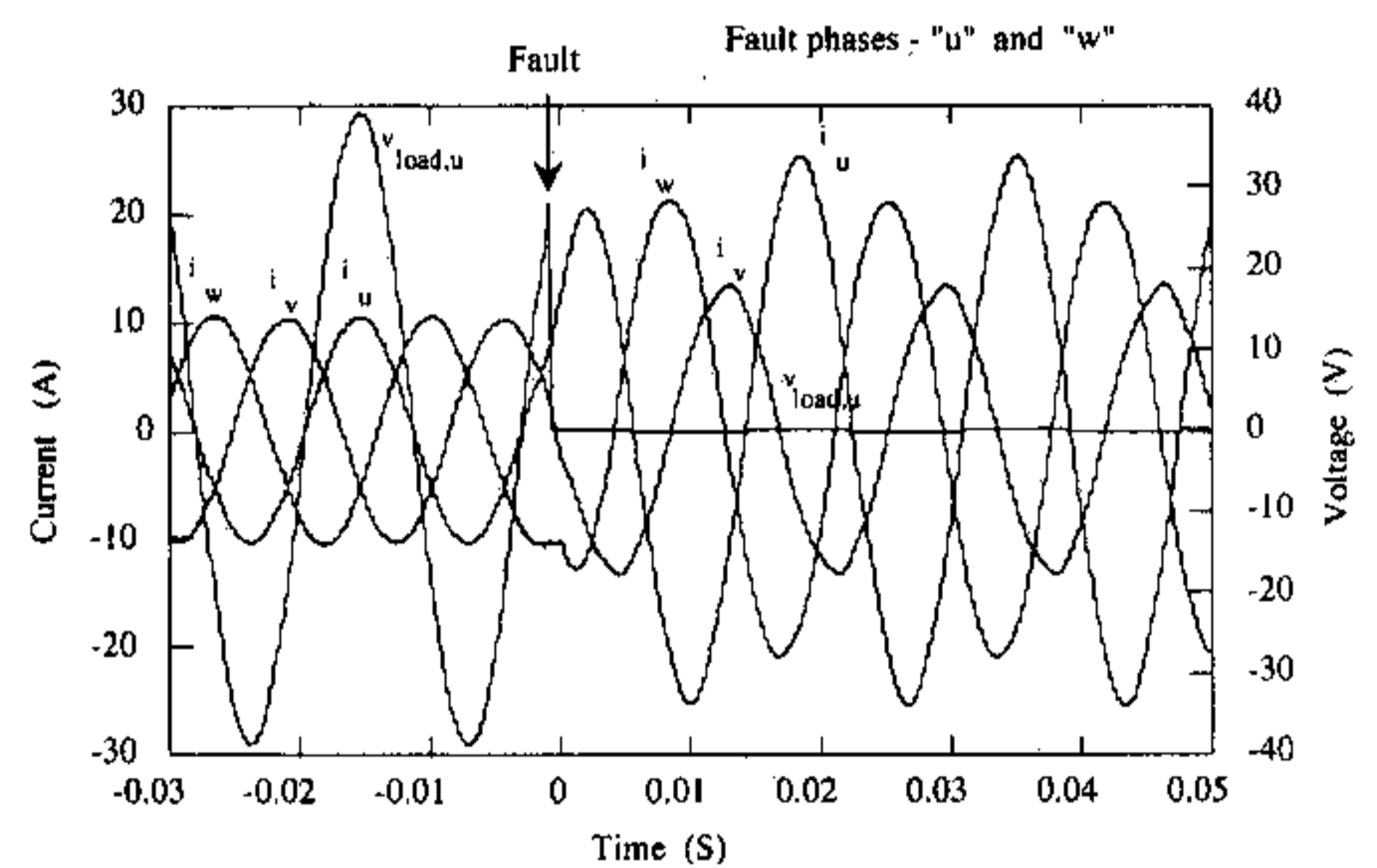

Fig. 10. Transient waveforms at double phase fault condition.

unsaturated state. In the simulation the B-H characteristics of the core have been represented by two straight lines; one representing the saturated condition with a magnetic permeability of μ_s and the other representing the unsaturated condition with a magnetic permeability of μ_u .

III. EXPERIMENTAL RESULTS AND DISCUSSION

Experiments were performed with circuit configuration shown in Fig. 2. Fig. 7 shows the experimental waveforms corresponding to the source voltage, current through the limiter, voltage across the limiter and load voltage of the u-phase under normal operating conditions. Fig. 8 shows the three-phase current waveforms and the voltage across the u-phase under a three-phase fault condition. The fault was initiated by closing the switches SW1 to SW3. The differences in the peak fault current values in the three phases may be due to the switching angle of the fault and the nonlinear coupled behavior of the limiter. Single phase and double phase fault were initiated and the experimental results are shown in Figs. 9 and 10 respectively. Again the current limiter properties under these two fault conditions are clearly visible.

The peak value of the fault current is limited to less than twice of the normal peak current. In the absence of the fault current limiter, the peak fault current is approximately 8 times greater than the normal peak current. The ratio of the unsaturated inductance to the saturated inductance is currently limited by the use of two magnetic materials. Placing a saturable core on either side of the magnet and replacing the existing core with

a high saturation flux density material will increase the ratio (lower the nominal voltage drop across the FCL) and allow for a greater degree of magnetic field uniformity within the core. An improvement in uniformity will lead 1) to a sharper transition from the nominal state to the current limited state and 2) to lower core losses.

IV. CONCLUSIONS

This paper has described, analyzed and experimentally verified a novel compact magnetic current limiter for three phase applications. A model has been fabricated in the laboratory and experiments were conducted. The experimental results indicate that the proposed current limiter is suitable for three phase applications.

REFERENCES

- [1] M. Iwahara, S. C. Mukhopadhyay, S. Yamada, and F. P. Dawson, "A full passive fault current limiter using the permanent magnet for the burden critical equipments," in *J. Nonlinear Electromagnetic Systems*: IOS Press, 1998, vol. 13, pp. 349-352.
- [2] S. C. Mukhopadhyay, M. Iwahara, S. Yamada, and F. P. Dawson, "Investigation of the performances of a permanent magnet biased fault current limiting reactor with a steel core," *IEEE Trans. Magn.*, vol. 34, no. 4, pp. 2150-2152, July 1998.
- [3] S. C. Mukhopadhyay, F. P. Dawson, M. Iwahara, and S. Yamada, "Analysis, design and experimental results for a passive current limiting device," *IEE Proc.—Electr. Power Appl.*, vol. 146, no. 3, pp. 309-316, May 1999.
- [4] M. Iwahara and E. Miyazawa, "A numerical method for calculation of electromagnetic circuits using the tableau approach," *IEEE Trans. Magn.*, vol. 19, pp. 2457-2459, Nov. 1983.